

98-1

MONOGRAPH



Construction, Maintenance, and Operation of a Glacial Runway, McMurdo Station, Antarctica

George L. Blaisdell, Renee M. Lang, Gerald Crist, Keith Kurtti, R. Jeffrey Harbin, and Daniel Flora

March 1998



Abstract: On 7 February 1994, a C-141 departed Christchurch, New Zealand, and landed on the 3050-m (10,000-ft) Pegasus glacial ice runway, located on the Ross Ice Shelf 13 km (8 miles) south of McMurdo, Antarctica. This event marked the final test for a five-year development program to demonstrate the feasibility of a semipermanent glacial ice runway capable of supporting heavy wheeled aircraft at a site easily accessible to McMurdo. In the later phases of developing the glacial ice runway, numerous working flights of LC-130s operating on wheels (rather than skis) moved cargo more efficiently to the South Pole, and the LC-130 and a C-130 carried larger passenger loads to Christ-

church. The primary benefit of the Pegasus runway to the U.S. Antarctic Program is its ability to support heavy wheeled aircraft for most of the period of mid-January through November. In the past, only ski-equipped aircraft could land in the McMurdo area during this time period. The Pegasus runway allows increased payloads for the LC-130 (an additional 3600-kg or 8000-lb takeoff weight when using wheels) and provides access for virtually any conventional aircraft. The technology for siting, constructing, maintaining, and operating such a runway is now well understood and is described in detail in this comprehensive report.

Cover: First C-141 Starlifter operation on a glacial ice runway (McMurdo, Antarctica; 7 February 1994). Following successful landing and taxi tests, the aircraft took on 54 passengers and priority cargo and completed the 6-hour return flight to Christchurch, New Zealand.

How to get copies of CRREL technical publications:

Department of Defense personnel and contractors may order reports through the Defense Technical Information Center:

DTIC-BR SUITE 0944
8725 JOHN J KINGMAN RD
FT BELVOIR VA 22060-6218
Telephone 1 800 225 3842
E-mail help@dtic.mil
msorders@dtic.mil
WWW http://www.dtic.dla.mil/

All others may order reports through the National Technical Information Service:

NTIS
5285 PORT ROYAL RD
SPRINGFIELD VA 22161
Telephone 1 703 487 4650
1 703 487 4639 (TDD for the hearing-impaired)
E-mail orders@ntis.fedworld.gov
WWW http://www.fedworld.gov/ntis/ntishome.html

A complete list of all CRREL technical publications is available from

USACRREL (CECRL-LP)
72 LYME RD
HANOVER NH 03755-1290
Telephone 1 603 646 4338
E-mail techpubs@crrel.usace.army.mil

For information on all aspects of the Cold Regions Research and Engineering Laboratory, visit our World Wide Web site:
<http://www.crrel.usace.army.mil>

Monograph 98-1

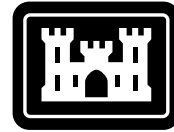

**US Army Corps
of Engineers®**
Cold Regions Research &
Engineering Laboratory

Construction, Maintenance, and Operation of a Glacial Runway, McMurdo Station, Antarctica

George L. Blaisdell, Renee M. Lang, Gerald Crist,
Keith Kurtti, R. Jeffrey Harbin, and Daniel Flora

March 1998

Prepared for
OFFICE OF POLAR PROGRAMS
NATIONAL SCIENCE FOUNDATION

Approved for public release; distribution is unlimited.

FOREWORD

This report is dedicated to Dr. Malcolm Mellor. His high level of energy and technical persuasion secured the support for this project. Malcolm eagerly drove the bulldozer making the first passes that exposed the glacial ice which would eventually lead to the Pegasus runway. We regret that, because of his untimely death, he did not have the opportunity to share in many of the discoveries made during the construction process, nor in the runway's successful completion and operation.



Photo by Charles Swithinbank

PREFACE

This report was prepared by George L. Blaisdell, Research Civil Engineer, Applied Research Division, U.S. Army Cold Regions Research and Engineering Laboratory, Hanover, New Hampshire, Renee M. Lang, Consultant, Sigma Technologies, Gerald Crist, Snow and Ice Construction Specialist, Antarctic Support Associates, Keith Kurtti, Fabricator, Antarctic Support Associates, R. Jeffrey Harbin, Operator, Antarctic Support Associates, and Daniel Flora, Snow and Ice Construction Specialist, Antarctic Support Associates.

This work was performed for the National Science Foundation, Office of Polar Programs under a Memorandum of Understanding with the U.S. Army Corps of Engineers. The authors thank NSF for the opportunity to conduct this study and for their continued support throughout the development.

The authors also thank Paul Sellmann and Dr. Charles Swithinbank for their technical review of this report.

The authors are very grateful to Antarctic Support Associates for their commitment to this project. Many individuals from ASA contributed greatly to its success. The authors are particularly thankful to the U.S. Navy's VXE-6 squadron and to the Naval Support Force–Antarctica. Without their willingness to try something new, the authors could have proven only that glacial ice could be graded flat and that it could support a concentrated load of ballast.

During the early phases of this project, the authors received advice and assistance from experts at the Russian Arctic and Antarctic Research Institute (AARI); their contribution was very beneficial.

The contents of this report are not to be used for advertising or promotional purposes. Citation of brand names does not constitute an official endorsement or approval of the use of such commercial products.

CONTENTS

	Page
Foreword	ii
Preface	iii
Executive summary	ix
Chapter 1. Introduction	1
Chapter 2. Site investigation	4
Initial siting	4
Physical properties of sites	4
Ice characteristics	4
Ice surface characteristics	9
Snow depth, accumulation, and ablation	10
Trend of accumulation/ablation transition	13
Snow drifting	13
Movement of glacier	15
Presence of contaminants	15
Flight plate	17
Logistical suitability	19
Access for construction	19
Establishing database	20
Weather characteristics	20
Ice temperature profile	21
Solar radiation	23
Topography and ice movement	25
Data analysis	25
Making site selection	25
Environmental impact evaluation	26
Chapter 3. Construction	27
Site development	27
Facilities	28
Access road	29
Initial open-up	30
Runway construction	34
First grading and inspection	35
Filling of low areas	40
Preparations for final grading	41
Final ice grading	42
Snow management during construction	44
Chapter 4. Runway certification	47
Small-scale mechanical tests	47
Full-scale load simulation	47
Patching	57
Roughness survey	60
Flight test	61
Chapter 5. Maintenance	65
Personnel	65
Snow management	65
Runway smoothness, surface definition, and friction coefficient	69
Surface cleanliness	70

	Page
Patching of ice damage and flaws	72
Preventing occurrence of melt features	72
Requirements for protective snow cover	75
Snow surface characteristics	77
Removal of protective snow cover	78
Monitoring and data acquisition	79
Chapter 6. Operations	80
Personnel	80
Infrastructure	81
Emergency provisions	84
Weather observations	85
Air and ground control	85
Payload	86
Aircraft parking	86
Proof rolling	87
Waste and pollution management	87
Scheduling	88
Chapter 7. Future considerations	89
Limits to life expectancy	89
Glacier movement	89
Concentration of contaminants	89
Snowdrifting	90
Climate effects	90
Future of the Pegasus runway	90
Demonstrated utility	90
Enhanced operational windows	91
Single vs. double operating window during austral summer	91
Austral winter operations	91
Potential for other aircraft	92
Search for alternative landing sites	92
Literature cited	92
Appendix A: Meteorological analyses of the Pegasus runway site	95
Appendix B: Environmental impact assessment for the Pegasus runway	97
Appendix C. Cross-sectional profiles over time of the Pegasus runway including flanking berms	113
Appendix D. Temperature profiles from the Pegasus runway ice.	115
Appendix E. As-built layout of the Pegasus runway and runway markers	121

ILLUSTRATIONS

Figure

1. Map of McMurdo area	1
2. Satellite image of McMurdo and Scott Base (New Zealand) located on the tip of Hut Point Peninsula	3
3. Thickness of floating freshwater ice recommended to support various size aircraft	5
4. Example of melt-refreeze ice with cylindrical bubbles	6

Figure	Page
5. Example of milky glacial ice	6
6. Stress-strain curve from ice at a depth of 10.5–15.5 cm, extracted at the south end of the runway	7
7. Stress-strain curve from ice at a depth of 20–27 cm, extracted at the south end of the runway	8
8. Thin section of typical melt/refreeze ice within glacier ice showing large crystals.....	9
9. Thin section of milky glacial ice showing fine-grained texture	9
10. Three-dimensional contour map of natural ice surface at the site chosen for the Pegasus runway	10
11. Bump analysis results for natural ice surface compared to military specifications for allowable bumps on runways	10
12. Airphotos of transition between zones of accumulation and ablation.....	11
13. Location of Pegasus runway relative to regional glaciological zones	14
14. View to west of bare ice starting 250 m (800 ft) west of edge of Pegasus runway	15
15. Mineral deposits in concentrated bands in ice	16
16. Layers of wind-blown contamination in snow	16
17. Rotted snow surface resulting from differential ablation brought on by localized concentrations of mineral particles deposited by wind.....	17
18. Moving sand trapped in sharp surface features on snow surface.....	18
19. Gap between Black and White Islands	18
20. Wheeled loader	20
21. Wind diagrams for the Pegasus South automated weather station using monthly average data for the period 1 January 1993 to 31 December 1994	21
22. Automatic weather station installed at the Pegasus site	22
23. Grader tracks showing breakthrough of thin ice cover over sub-surface melt pool	22
24. Radiometer pair used to measure albedo of snow and ice surfaces	24
25. Shelter for workers at Pegasus runway	28
26. Tool shed and latrine at Pegasus runway	29
27. Initial snow stripping on the Pegasus runway using a grader-mounted V-plow	30
28. Initial snow stripping on the Pegasus runway using a bulldozer with U-blade.....	31
29. Adjustable skids used to hold equipment blades a fixed distance above the ice surface	32
30. Ripper equipped with skids on outer teeth	33
31. Rolba ribbon-type snowblower mounted on Oshkosh truck.....	33
32. Ice surface following initial snow stripping	34
33. Custom-built aggressive grader blade used for initial rough grading of runway	35
34. Aggressive grader blade removing up to 20 cm (8 in.) of glacial ice in one pass	36
35. Small ice blister formed from freezeup of melt pool showing radial cracks.....	36
36. Attitude of grader blade and chisel-teeth during grading	37

Figure	Page
37. Aggressive tire chains as used in logging industry installed on motor grader to reduce slip during ice grading	37
38. Mineral matter trapped in the ice	38
39. Ice surface following initial grading	38
40. NCEL ice grinder	39
41. Poorly consolidated ice including snow pockets	39
42. Portable snow melter	40
43. Final grade plan for the Pegasus runway	41
44. Motor grader under laser control during final grading of ice	42
45. Custom built chisel-tooth grader blade used during finish grading of runway	42
46. Geometry of individual chisel teeth.....	43
47. Finish-graded ice surface seen in foreground with rough-graded segment of runway in background	44
48. Small windrows trapping blowing snow.....	45
49. Cart for proof rolling the Pegasus runway shown configured for C-130 landing gear	48
50. Proof cart configured for C-141 landing gear and ballasted with a steel plate and concrete blocks	49
51. Site of failed runway ice caused by proof cart	50
52. Closely spaced proof cart tire tracks during full-scale load certification of runway	50
53. Failure planes in ice extending into sides of main cavity of failed area	51
54. Sketch map of locations on runway where proof cart failed ice.....	51
55. Horizontal and vertical thin sections of core sample removed from the Pegasus runway surface at the 6000-ft zone	52
56. Horizontal and vertical thin sections of core sample removed from the Pegasus runway surface at the 10,000-ft zone	55
57. Horizontal and vertical thin sections at 10.3- to 20.5-cm horizon of core sample removed from the Pegasus runway surface at the 0-ft zone	55
58. Dissected ice blister showing gap between upper melt/refreeze ice and lower natural glacial ice	56
59. Ice failure site cleaned out and ready for patching	58
60. Freshwater filling of cavity during patching	59
61. Freshly patched failure site approximately 4 hours after flooding with water	59
62. Tracks of proof cart on area patched 48 hours earlier	60
63. Cosine bump analysis results for finish-graded runway	61
64. Bump analysis results for finish-graded ice compared to military specifications for allowable bumps on runways	61
65. LC-130 operating on wheels during runway testing of Pegasus in February 1993	62
66. First tracks of aircraft tires on newly constructed glacial ice runway	63
67. C-141 takeoff from the Pegasus runway following successful tests in February 1994	64
68. Windrow drag used to encourage snow accumulation	66
69. Small snow plane with minor height adjustability	67
70. Medium snow plane with height and blade attack angle adjustability	67

Figure	Page
71. Long-base snow plane with height adjustability	67
72. Heavy pneumatic-tire roller	68
73. Drag made from heavy I-beam	68
74. Exposed ice (blue ice) at inland locations	69
75. Conventional C-130 performing routine landing on the glacial ice runway	70
76. Ratio of shortwave solar radiation at depth x in the snowpack (Q_x) to shortwave solar radiation absorbed at the snow surface (Q_a)	72
77. Bulk extinction coefficient for snow	73
78. Ambient temperatures recorded at the “Pegasus North” AWS	73
79. Ice surface temperatures at 2000-ft marker on the east edge of the runway throughout the 1992–93 and 1993–94 austral summers	74
80. Adjustable skids used to assist in “floating” grader blade	76
81. Exclusion zone maintained on the Pegasus runway during air operations	82
82. General location of support facilities at Pegasus during air operations	83
83. Passenger terminal used during air operations at the Pegasus runway	83
84. Conventional C-130 during frequent routine operations from the Pegasus glacial ice runway	91

EXECUTIVE SUMMARY

INTRODUCTION

The U.S. Antarctic Program (USAP) relies on aircraft operating between Christchurch, New Zealand, and McMurdo to provide nearly all personnel support and a considerable amount of cargo transport to the continent, excluding support for Palmer Station on the Antarctic Peninsula. The first flights of the season land on a deep snow skiway at Williams Field in late August using ski-wheel-equipped LC-130 Hercules aircraft. In October, the main body of personnel fly to McMurdo in wheeled C-130 Hercules, C-141 Starlifter, and C-5 Galaxy aircraft. These aircraft land on a runway of first-year sea ice. The sea ice runway is used by these conventional (wheeled) airplanes until its surface strength deteriorates in mid-December.

Until the 1992–93 season, the USAP was limited solely to the LC-130s for all air transport from the time the sea ice runway closed throughout the remainder of the season. There are now very few LC-130s available: five owned by the National Science Foundation and operated by the U.S. Navy, and four contracted from the New York Air National Guard for brief periods. With the many requirements for their use, a backlog of personnel and crucial cargo normally occurred that severely constrained the Program during mid- and late season.

To alleviate this problem, the USAP sought a means of utilizing conventional aircraft in the latter part of the austral summer. However, this required a reliable runway capable of supporting wheeled aircraft. Candidates included runways on multiyear sea ice, on glacial ice, and those made from crushed rock or compressed snow.

RUNWAY DEVELOPMENT

Beginning in the 1989–90 summer season, engineering studies were directed at determining the feasibility of producing a wheeled aircraft runway on the Ross Ice Shelf near McMurdo, specifically for use during the period after the sea ice has deteriorated. The Pegasus runway was carefully sited in an area with a thin, but permanent and complete, snow cover. This snow is underlain by a contiguous mass of glacial ice that is derived from natural seasonal meltwater (near the surface) and ice formed by metamorphosis of snow. The supply of highly reflective snow available at the Pegasus site is necessary as a source for protecting the runway from deterioration due to the effects of absorbed solar radiation.

Construction

The snow cover was stripped from a surveyed 10,000- × 300-ft (3050- × 91-m) area to expose the undulating ice surface. This was completed during the 1991–92 season along with rough grading and “filling” of low areas by flood water from a portable snow melter.

Beginning in August of 1992, overwinter snow was removed from the area. A survey of the ice surface was used to establish the desired grade for the runway in order to minimize construction. A laser-guided grader with a specially built chisel-tool blade was used to level the ice surface to a smoothness in excess of published

allowable standards for military aircraft. A snowblower was used to remove graded ice from the runway. Grading and clearing were completed at the end of October.

Protection during peak solar period

During December and the first half of January, relatively high temperatures (near melting) and intense (24-hour/day) sunshine predominate in McMurdo. Under such conditions, exposed ice absorbs radiation and often reaches the melting point. Melting may take place either on the surface or at a level slightly below the top of the ice. Melting can often become widespread and can create very large melt pools that could destroy the possibility of using a runway before complete refreezing in March or later.

To protect against melting, the graded ice surface is covered with a 10-in. (25-cm) layer of snow. Material from along the sides of the runway or overwinter snow present on the runway provides the source for this cover. This protective snow cover must be in place by the end of November, just prior to the peak of the austral summer.

Throughout December and the first week of January, the snow cover requires some compaction, accomplished with heavy, rubber-tired rollers. Planing and dragging is also done to assist in preserving the snow and to provide a highly reflective, porous surface. Measurement of air, snow, and subsurface ice temperatures, together with the intensity of the incoming solar radiation, is done to monitor snow cover performance. Processing activities on the snow cover are governed by these measurements to ensure that melting of the shelf ice does not occur.

Sometime between 7 and 15 January, the air temperature usually begins its downward trend. Within several days of the onset of cooling the average daily air temperature drops below the highest measured runway ice temperature. With the annual cooling trend thus established, the protective snow cover can be stripped from the runway.

Certification of runway strength

In preparation for wheeled Hercules operations at the end of the 1992–93 season, the integrity of the runway was tested with a proof roller. The cart replicated the main landing gear of a C-130 and was ballasted to a level more than 30% greater than the maximum allowable load for each tire. The runway was tracked with the proof roller with more extensive coverage along the central 100 ft (30.5 m). Total coverage of the runway by the proof roller tires amounted to close to 50% of the surface.

Approximately 30 weak spots were found by the proof roller. In these locations, the ice failed by crumbling, leaving a slight depression in the surface. Excavation of failed points revealed that they had an average size of 30 ft² (2.8 m²) and were 6–18 in. (15–46 cm) deep. In nearly every case, failure points were associated with a thin (0.25- to 0.5-in., 0.6- to 1.2-cm) gap. This gap was most likely caused during refreezing of melt pools that were known to have been present at this site during the 1991–92 summer season.

Each failure point was excavated and all of the fractured ice around the edges was dislodged. The ice chunks were broken into fist-sized pieces and packed into the cavity. Cold water was then used to flood the cavity, making an ice bath that froze completely within 48 hours. Numerous patched spots were re-proof-tested and all were found to be sound. The runway was therefore certified for operation of wheeled Hercules aircraft.

The goal of the 1993–94 season was to certify the runway for C-141 Starlifter operations. The proof cart was reconfigured to duplicate the C-141 main landing gear and was ballasted to a load of 384,000 lb (174,000 kg), approximately 25% greater than the maximum takeoff load on the main gear. The tires were inflated to 260 psi (1791 kPa), compared to the 200-psi (1396-kPa) maximum pressure for the C-141.

Proof testing of the runway for C-141 aircraft covered more than 50% of the runway surface, with tire tracks being no more than 3 ft (1 m) apart. No failures were found of the type seen the prior year. Several shallow gouges from the bulldozer blade used to clear winter-over snow were detected and they were patched. Proof testing was completed in two days, and the runway was then dragged and planed to provide an extremely smooth operating surface. The runway was certified for C-130 and C-141 operations and opened for air operations on 25 January, 1994.

Test flights

Before becoming operational for wheeled aircraft, a flight test was performed to determine the high-speed characteristics and surface traction of the runway. On 6 February 1993, an LC-130 operating on wheels performed tests including a light landing (102,000 lb or 46,250 kg), high-speed taxi, steering, braking (including locked wheel), heavy takeoff (125,000 lb or 56,700 kg), touch-and-go landing, full-stop landing, taxi on skis, and an opposite direction takeoff. All test flight results were deemed excellent by the flight crew, and runway engineers noted no ill effects to the runway surface. The runway was then opened for Hercules operations for the remainder of the 1992–93 season.

In preparation for the C-141 flight test in early February 1994, we again utilized an LC-130. On 25 January 1994, an empty Hercules returning from the South Pole landed and completed high-speed taxi tests, braking tests, and a takeoff, all from wheels. The flight crew reported that the runway had a superb operating surface and that the runway was visible from 60 miles (97 km) away when approaching on a clear day. They also reported that the surface was smoother than most of the concrete runways from which they operate.

On 7 February 1994, a C-141 flew from Christchurch to a landing on the Pegasus glacial ice runway. The plane weighed 230,000 lb (104,300 kg) on landing. It touched down exactly at the north-end zero threshold and had reached a slow taxi speed within 6,000 ft (1830 m) using wheel brakes and a slight amount of reverse thrust. Snow billowing was not a problem. One to 3 in. of processed snow cover was present on the ice surface, and the plane appeared to displace the snow only where more than 2 in. (5 cm) were present or where prior C-130 wheel tracks had existed. The C-141 taxied the full length of the runway and executed its turn-around at the south end without difficulty. The plane slowly taxied back to the ramp at the north end and again turned fully to align with the fuel pit on the west side of the ramp. Some front wheel skidding occurred during this sharp turn.

Conversations with the pilot and crew indicated extreme satisfaction with the runway. They remarked on the degree of smoothness; ground observers at the 5000-ft mark could detect no wing deflections at touch-down or during run-out. The C-141 was then fueled and loaded with three pallets of priority science cargo and 54 passengers, bringing the aircraft to a total weight of 280,000 lb (127,000 kg). It proceeded with takeoff, pulling clear of the runway at the 5000-ft (1520-m) mark. The runway suffered no damage from the C-141 operation.

Flight operations

Full flight operations began from the Pegasus runway on 8 February 1993. LC-130 aircraft were used to fly cargo from the Pegasus runway to the South Pole allowing an extra 8,000 lb (3630 kg) of payload by taking off on wheels. A total of eight flights to the South Pole used the Pegasus runway in 1993, delivering 220,500 lb (100,000 kg) of cargo. The Pegasus runway was also used to fly passengers to Christchurch with LC-130s operating on wheels and a standard C-130. Passenger counts of 30–50 were thus possible, compared to the usual 15–30 when taking off on skis. Four flights by a standard C-130 were completed with 50 passengers transported on each trip. A total of 593 passengers and 32,000 lb (14,500 kg) of cargo was delivered to Christchurch from the Pegasus runway in 1993.

The runway was closely inspected by project engineers following each of the first 15 flights. No damage or wear could be detected and no ice failures occurred.

The 1994 operating season at Pegasus began on 26 January and extended through 27 February. Numerous LC-130 flights (on wheels) were operated in supplying South Pole station, and a C-130 was operated between Christchurch and Pegasus on an every-other-day basis, starting around the 1st of February. In all, about 55 flights used the runway, saving the USAP more than 25 flights because of the heavier loads that can be carried by wheeled aircraft. Similar operational seasons were achieved from Pegasus during 1995, 1996, and 1997.

COST AND BENEFITS

The total cost of the Pegasus project is difficult to determine because of the wide range of resource centers that provided support. For the last two years, the combined records of the Pegasus crew, Williams Field Public Works department, and CRREL indicate that about \$350,000 was spent each year. Over the five-year period, approximately 17,000 hours of work were expended at the runway for a crew consisting of between two and five persons. Capital equipment purchased specifically for this project include a grader and snowblower, which were critical to the runway construction, and other essential equipment such as the proof cart and several snow planes. In total, we estimate that the Pegasus project cost the National Science Foundation about \$1.65 million over the course of the five-year development period.

The cost of the Pegasus runway can be compared to the savings that it generates. It is difficult to quantify much of the benefit of Pegasus runway; however, we can cite many factors including reduced wear and tear on airframes, more efficient use of aircraft and flight crews, less wasted time by science and support personnel waiting for seats on outbound aircraft (Pegasus provides a reliable number of seats for each flight), enhanced morale (program participants now have confidence in their redeployment date), assurance of stocking South Pole before station close, increased efficiency for cargo handlers at South Pole, and timely station closeout despite late vessel arrival or storms. Access by much of the world's aircraft and the potential for winter flights are also gained.

One calculation that can easily be made has to do with reduced numbers of flights. By comparing maximum takeoff weights, we figure that two flights from Pegasus (wheels) are equal to three from Williams Field (skis). In 1993, 23 flights operated from Pegasus, and about 55 flights left the runway in 1994. Fifty-five or more flights used Pegasus during each of the 1995, 1996, and 1997 seasons. Thus, at least 122

flights have been saved since 1993. If we assume that half of these would have gone to the South Pole (6-hour round-trip) and half to Christchurch (16-hour round-trip), more than 1340 flight-hours have been saved. An accepted cost for the Hercules (including fuel) is \$3000 per hour, which results in a cost savings to date of more than \$4 million.

LIMITS TO LIFE EXPECTANCY

Being located on a glacier, the Pegasus runway is moving. The current movement is at a rate of about 1 to 2 ft per year northward. This is a favorable direction from the standpoint of the glaciological conditions at the site. The ice shelf edge is currently located about 2 miles north of the north end of the runway. It is virtually assured that the ice shelf will calve in this area at some time in the future, but when this will happen, and how far into the shelf the break will occur is completely unknown. We speculate that other factors will cause deterioration of the site before the runway calves and heads out to sea.

It is also unlikely that crevasses or other cracks will invade the runway site. Since the site is located "downstream" and some distance from constrictions on the ice mass, there is no source of deviatoric stress to produce large cracks.

Mineral particles from nearby exposed rock sources (e.g., Black Island), blown onto the runway by storms, may provide the biggest threat to the longevity of the runway. Over the past four years, strong winds have on a number of occasions deposited bands of small mineral particles throughout the region of the runway. However, in only one case has there been mineral contamination blown onto the runway itself.

Contaminants from equipment and personnel on the site must also be considered. Fuel, oil, or coolant leaks and spills could be difficult to clean and could be devastating to a portion of the runway or support areas.

If an exceptionally warm summer were to occur, the techniques we have established are likely to fully protect the runway from melt problems. However, free water occurring in the vicinity of the runway might be expected to flow on the ice surface and could infiltrate the runway.

Construction and maintenance activities at the site have altered the topography of the snow surface. This could result in a change in the natural balance of accumulation/ablation, which will undoubtedly increase the amount of work required to maintain the runway. Substantial berms are now present along both sides of the runway. To avoid serious snowdrifting problems, the berms must be significantly reduced in size during the next summer season. Ultimately, snowdrifting could still threaten the life of the runway over the long term.

The Pegasus site was deliberately chosen on the fringe of a large established ablation region. If a climate change occurs (e.g., a series of abnormally warm summers or an increase in solar intensity due to depleted ozone), the edges of the ablation region may move outward, thus threatening the runway's integrity.

Further experience with the Pegasus runway, and continued research into the natural dynamics of the site will result in means to cope with each of these threats. From our current experience at this site, we believe that the runway could be made to operate successfully for at least 10 years unless a calving event occurs and threatens the runway.

FUTURE

We have demonstrated the utility of the Pegasus runway for late season (mid-January to the end of February) use by LC-130s delivering cargo to South Pole Station and for redeployment of personnel to Christchurch using either C-130s or C-141s. Continued reliance on the Pegasus runway for these uses alone justifies its maintenance.

Enhanced operating windows

The Pegasus runway also provides the USAP with enhanced aircraft operating windows. The runway will allow wheeled C-130 operations year-round. Other wheeled aircraft with higher tire pressures (e.g., C-141) could, in most years, access the runway from mid-January to about 15 November. Skied aircraft can use the runway throughout the year. Mechanical testing of ice strength and proof testing of the runway at different times of the year when flight operations are desired will identify runway integrity for different temperature regimes.

Potential for other aircraft

Having shown that the Pegasus runway can support the C-141, we believe that virtually any aircraft could safely operate from it as well. Certification for other aircraft will, of course, be necessary, with attention paid to the tire load and contact pressure, landing gear arrangement, and total and “gang” load. This opens the possibility for the USAP to increase utilization of New Zealand’s or another Antarctic partner’s aircraft resources. In addition, it may be beneficial to consider passenger planes flown by a commercial contractor for the majority of the personnel transport needs. Cargo aircraft could then focus entirely on moving goods and supplies.

Construction, Maintenance, and Operation of a Glacial Ice Runway, McMurdo Station, Antarctica

GEORGE L. BLAISDELL, RENEE M. LANG, GERALD CRIST,
KEITH KURTTI, R. JEFFREY HARBIN, AND DANIEL FLORA

CHAPTER 1. INTRODUCTION

The U.S. Antarctic Program (USAP) relies on aircraft operating between Christchurch, New Zealand, and McMurdo Station (78°S, 167°E; Fig. 1) to provide nearly all personnel support and a considerable amount of cargo transport to the continent (excluding support for Palmer Station on the Antarctic Peninsula). The first flights of the season land on a skiway at Williams Field (13 km east of McMurdo on the Ross Ice Shelf) in late August using specialized LC-130 Hercules (ski-wheel). In October, the main body of personnel fly to McMurdo in wheeled C-130 Hercules, C-141 Starlifter, and C-5 Galaxy aircraft. These aircraft land on a runway on first- or second-year sea ice. The sea ice runway is used by these conventional (wheeled) airplanes until its surface strength deteriorates in mid-December.

Until the 1992–93 season, the USAP was limited solely to the LC-130s operating from a skiway at Williams Field for all of its needs from the time the sea ice runway closed throughout the remainder of the season (Fig. 2). There are very few LC-130s available: five owned by the National Science Foundation and operated by the U.S. Navy, and four contracted from the New York Air National Guard for brief periods. With the many requirements for their use, historically a backlog of personnel and crucial cargo occurred and severely constrained the program during mid- and late season.

To alleviate this problem, the USAP sought a means of utilizing conventional aircraft in the latter part of the austral summer. However, this required a reliable runway capable of supporting wheeled aircraft. Candidates included runways on annual or multiyear sea ice (Barthelemy 1992),

on glacial (blue) ice (Mellor and Swithinbank 1989), and those made from crushed rock (Engler et al. 1990) or compressed snow (Blaisdell et al. 1995). Beginning in the 1989–90 summer season, engineering studies were directed at determining the feasibility of producing a wheeled runway on the Ross Ice Shelf near McMurdo, specifically for use during the period after the sea ice was no longer usable. In February of 1993, a 3050-m (10,000-ft) runway on glacial ice at the Pegasus site (Fig. 2) was demonstrated and first used by LC-130 aircraft operating strictly on wheels and by a C-130 Hercules. These aircraft shuttled cargo to the South Pole, landing on skis after taking off on wheels at a weight 3000–3600 kg (7000–8000 lb) greater than if doing so on skis. They also ferried passengers to Christchurch, carrying an additional 15 to 20 persons when taking off on wheels. During late January and much of February 1994, the Pegasus runway was used extensively for wheeled operations of LC-130 and C-130 planes. Flight tests with a C-141 were also successfully performed.

This report describes what was learned in the process of developing a glacial ice runway for heavy wheeled aircraft at the Pegasus site. Specifically, it presents a detailed account of the issues pertinent to construction, maintenance, and operation of a semipermanent runway of this type. The report attempts to generalize the concepts used to successfully produce a glacial ice runway for heavy wheeled aircraft, with the belief that they can be applied to any location where an ice runway could exist. We feel that this is equally true for all types of glacial ice runways. The Pegasus runway is situated on superimposed ice,

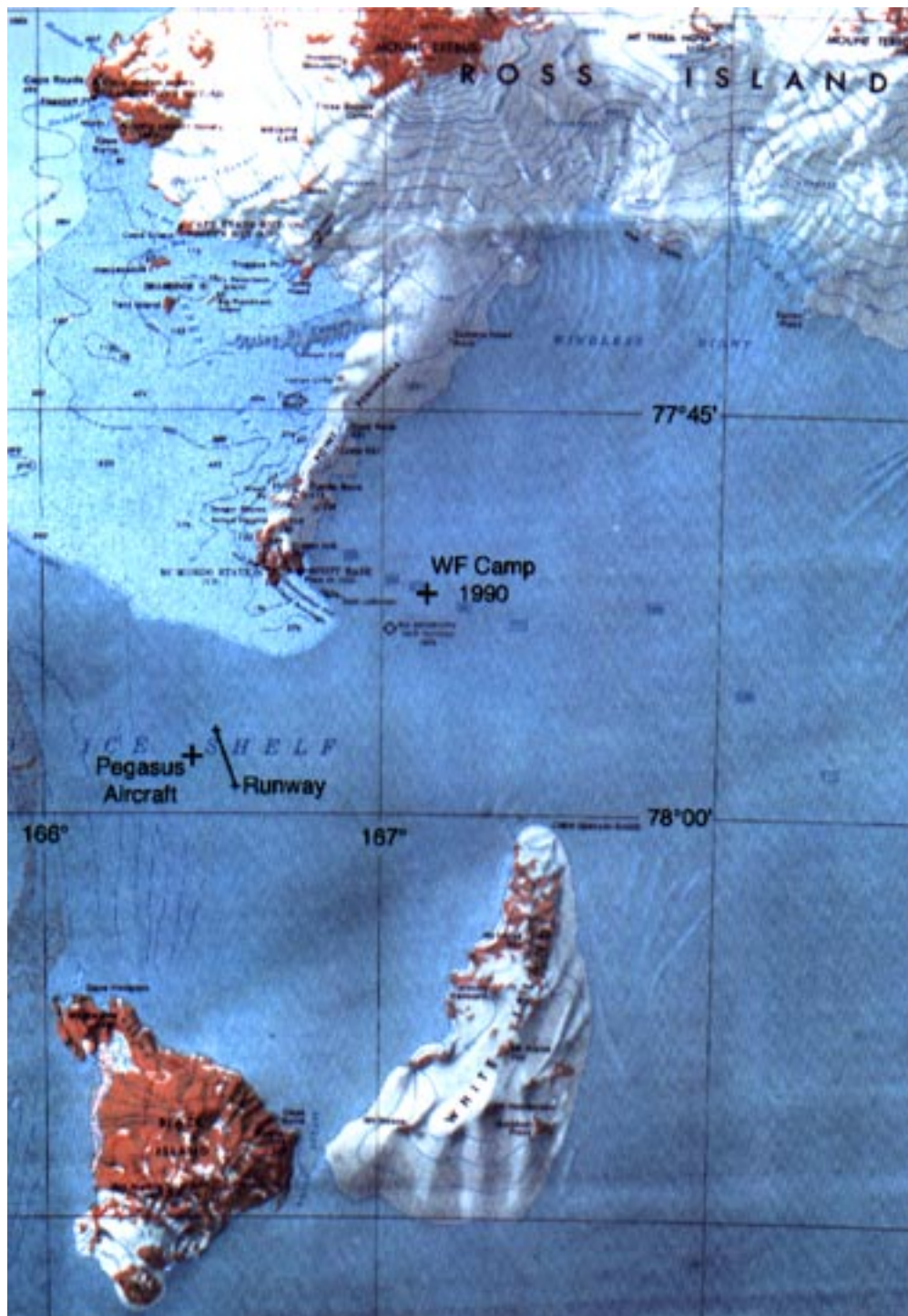

Figure 1. Map of McMurdo area.

and thus is of the type that will be considerably more expensive to develop than a runway fortunate enough to use natural ablation areas (commonly called “blue ice”). In the case of natural blue-ice sites, such as can be found in a number of locations in the interior of Antarctica, many of the

complications present when working on superimposed ice are avoided. For example, DC-4, DC-6B, LC-130, and C-130 aircraft have landed on wheels at natural unprepared blue ice sites in Antarctica, involving essentially no development cost (Swithinbank, 1992, 1993a, 1993b, 1994).

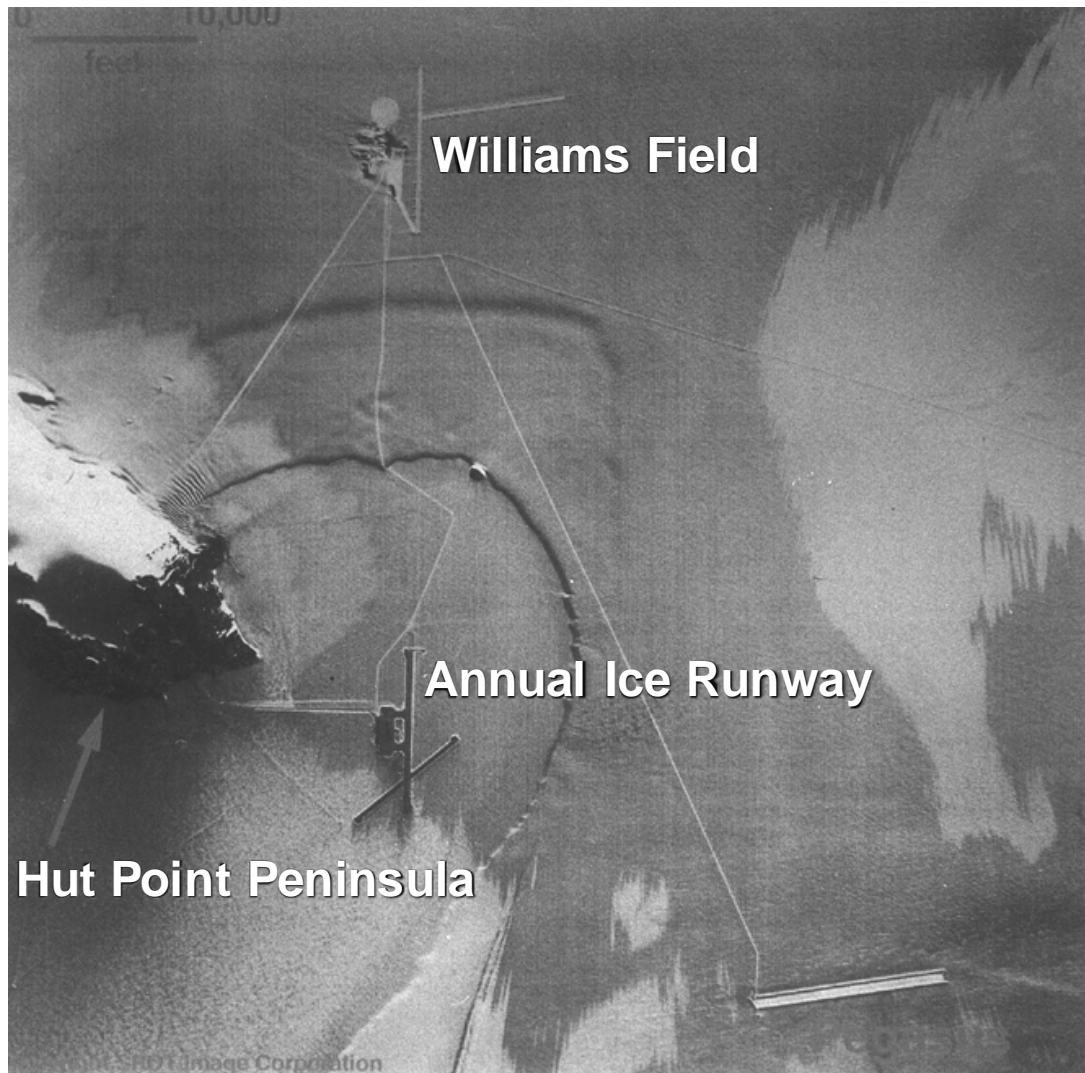

Figure 2. Satellite image of McMurdo and Scott Base (New Zealand) located on the tip of Hut Point Peninsula, the annual sea ice runway complex (center), Williams Field skiway (top), Pegasus glacial ice runway (lower right), and the snow roads connecting these sites. (SPOT HRV image ID 30445569412011812251P ©1994 CNES, Licensed by SPOT Image Corporation, Reston, Virginia.)

In this report the specific techniques and equipment used in the case of the Pegasus runway are fully described to provide an example and to allow this document to act as a resource in the long-term management of the Pegasus runway at McMurdo. In addition, we deal almost exclusively with issues on the ground at the site of a glacial ice runway. Anyone seriously interested in Antarctic air operations will need to become familiar with matters such as weather maps and forecasting, navigation and radio communication, temperate world departure points and ports of entry in Antarctica, suitable aircraft types, Antarctic flight conventions, and existing runways and fa-

cilities including fuel. Mellor's reports (Mellor 1988, 1993) provide an excellent starting point for much of this information. The Antarctic Flight Information Manual (AFIM) is another valuable resource*. In the McMurdo area, the Air Operations Manual CNSFAINST 3710.2L, published by the Commander, Naval Support Force Antarctica, is an important source of information†.

*Available from the COMNAP Secretariat, c/o American Geophysical Union, 2000 Florida Avenue, Washington, D.C., 20009-1277.

†Available from Office of Polar Programs, National Science Foundation, 4201 Wilson Boulevard, Arlington, Virginia, 22230.

CHAPTER 2. SITE INVESTIGATION

Consideration of potential glacial ice runway sites should be based on a well-established list of performance needs. Only then can preliminary site selection be undertaken. The type of aircraft available for use, the times of year for operation, the expected life of the facility, the locations requiring air service support, and the volume of personnel and goods needed must be fully considered. These performance criteria, and perhaps others unique to a particular user, will dictate the length, width, elevation, smoothness, bearing capacity, and suitable geographic setting of the runway. Standard aircraft manufacturer's literature will suggest runway dimensions for each model of aircraft, assuming a conventional surface material (paved or rock). However, since a glacial ice runway will dictate operating at lower levels of friction coefficient, with possible blowing snow and poor contrast (visibility) and minimal navigational aids and support equipment (tow vehicles, crash tenders, hangars, etc.), it is prudent to plan for the runway to exceed the recommended dimensions by at least 50%.

A number of potential sites should be considered in the early stages of locating the facility. Concurrent investigation of several sites will reduce the possibility of long delays, if undesirable features are discovered, and will allow for a comparison of the merits and challenges of certain locations. Rarely will an ideal location be found, and compromise, based on the specific needs and resources of the facilities users, will govern the siting of the glacial ice runway.

INITIAL SITING

Initial selection of potential sites in the region of interest for a glacial ice runway, especially in a remote area, should be accomplished using aerial photos and Landsat images. For example, potential sites in Antarctica were reviewed by Swithinbank (1989, 1991) using airphoto libraries. After identification of large ice expanses, sites will be examined that have level topography and are several miles distant from tall obstacles (e.g., mountains). The aerial images should also be scanned for deleterious large-scale topographic features such as crevasses or discontinuities in the ice. In some areas a thin snow cover may exist over sound

glacial ice, and these sites should not be immediately ruled out. In fact, if the region of desired runway location has mild temperatures for any portion of the summer season, snow is needed for maintenance of the runway. In areas that could have temperatures above about -10°C , particular attention should be paid to features that suggest seasonal melting on a regular basis. Examples of this might include stream-like features, melt/refreeze glacial ice blisters, plumes of dirt and gravel, or "rotted" snow surfaces.

Based on historical records, site visits at several times of the year over a two-year period and airphotos, Mellor (1988) selected the general area of the ablation/accumulation transition zone on the McMurdo Ice Shelf as most suitable for a glacial ice runway.

PHYSICAL PROPERTIES OF SITES

Following the initial selection of potential sites, the specific characteristics of each of the locations must be determined (for example, Kovacs and Abele 1977, Mellor and Swithinbank 1989, DenHartog 1993). This will involve visits to the sites that may require helicopter, small fixed wing aircraft, or off-road vehicle support. Mellor and Swithinbank (1989) completed the early site analysis on the McMurdo Ice Shelf, and narrowed down the appropriate region for a glacial ice runway to the Pegasus site.

Ice characteristics

Perhaps the most important aspect of selecting a glacial ice runway site is to ensure that the ice is sound and will support the type of aircraft planned for use on the runway. Information on the subsurface ice can be attained using various kinds of nonintrusive methods. Penetrating devices like radar (Arcone et al. 1994) and microwave may be able to provide key initial information as to the ice's integrity. However, ice cores will be needed to augment the output from such devices, and much can be learned through an ice coring program in the area where it is most likely the runway would be situated. Since the runway itself will cover a large area, cores should be taken over a wide range of possible ice types and features at the site. The goal will be to avoid being surprised by a weak ice area or undesirable features after construction has begun. Unlike conventional run-

ways in the temperate world, it is very difficult to replace or fix large flaws in glacial ice.

Cores should be taken to a depth of about 2 m (6.5 ft). The core should be inspected for obvious discontinuities such as changes in ice type, snow or disaggregated ice layers, mineral horizons, or gaps. Segments of the core should be tested for compressive strength using conventional techniques (Lang and Blaisdell, in prep.). Tests should be completed for the topmost 15 cm (6 in.) and for samples centered at depths in the core of 30, 60, and 90 cm (12, 24, and 36 in.). As a minimum, the ice strength should be 25% greater than the highest contact stress for any design aircraft. Care should be taken to ensure the compression tests be performed on each distinct ice type identified within the region of consideration. If sound core segments cannot be obtained, the coring tool may be used for fragmenting the ice (in which case a better tool should be utilized) or the ice itself may have low strength.

Discontinuities within the core will be of particular interest. The lateral extent and depth of such horizons must be assessed, along with their effect on the strength of the ice column. In some cases, a change in ice type at a depth of at least 0.5

m will not degrade the ability of the ice to support heavy aircraft as long as the two ice types are in intimate contact (i.e., no gap exists). Construction activities to smooth the ice may bring the discontinuity much closer to the surface, and compression tests should be attempted with samples that include the horizon. The results of this test can then be compared to the strength recorded for samples from above and below the discontinuity to determine the “weak link.” If the discontinuity is marked by a gap or snow horizon, this will most likely govern the ultimate load bearing capacity of the ice surface. Mineral horizons will degrade the strength of the discontinuity in direct proportion to the quantity and concentration of the rock particles.

The thickness of the ice should also be measured or estimated. Two types of glacial ice conditions could exist: alpine or continental glaciers and ice shelves where the ice is supported by water. In general, a glacier with sound ice and founded on rock will be able to support typical aircraft loads. However, glacial shelf ice must be of sufficient thickness to resist bending failure. Guidelines for minimum freshwater ice thickness to support wheeled aircraft are shown in Figure 3

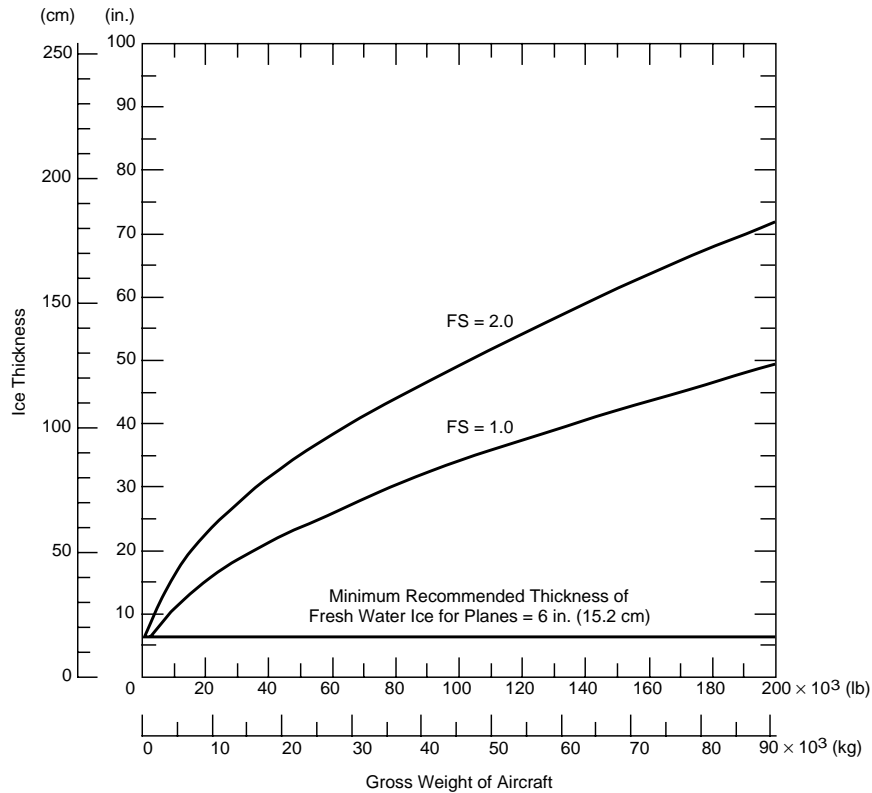

Figure 3. Thickness of floating freshwater ice recommended to support various size aircraft.

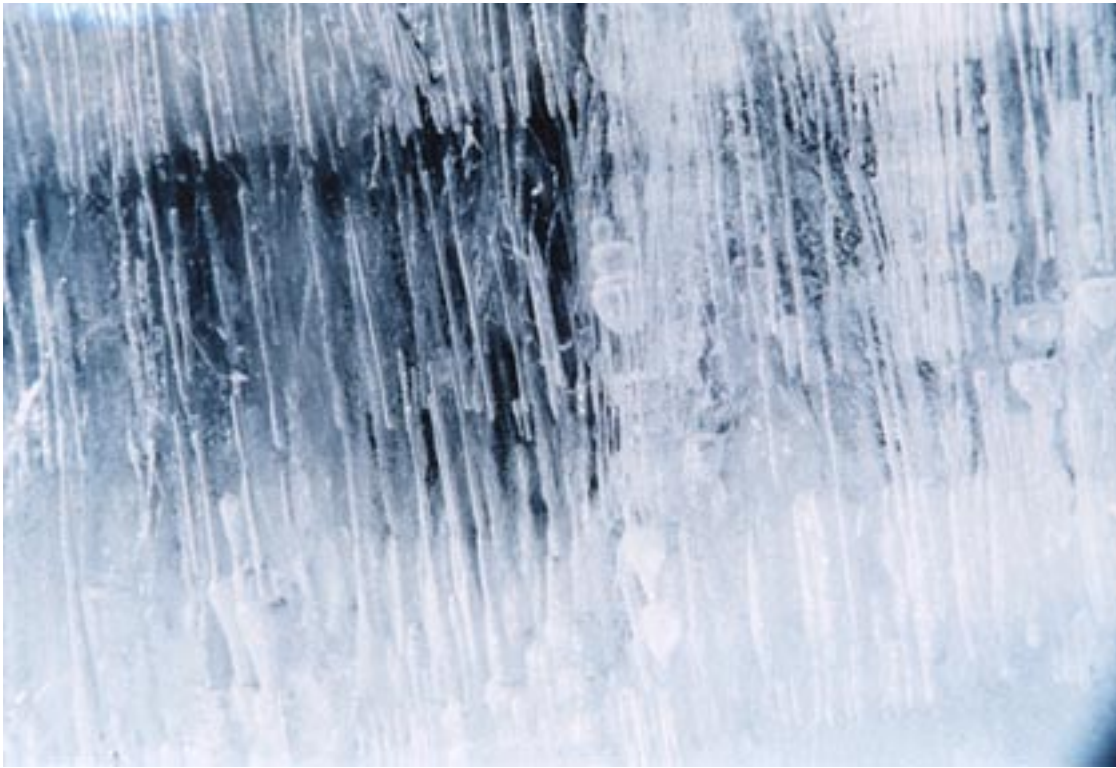

Figure 4. Example of melt/refreeze ice with cylindrical bubbles.



Figure 5. Example of milky glacial ice.

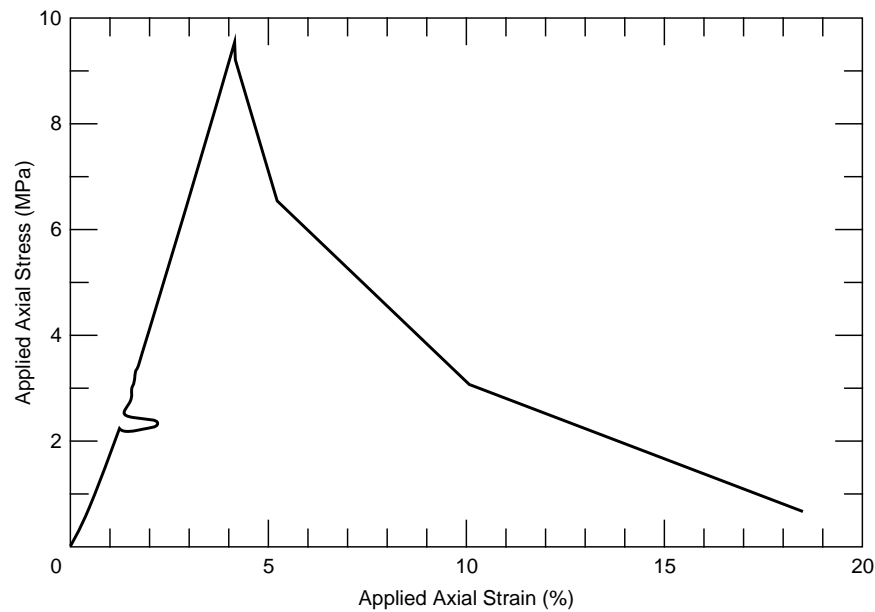

Figure 6. Stress-strain curve from ice at a depth of 10.5–15.5 cm, extracted at the south end of the runway (10,000 ft). Applied loading rate was 44.5 kN/s.

(U.S. Army and Air Force 1968). A more rigorous approach, specifically for glacial ice, should follow the system developed within the USAP for determining suitable floating sea ice thicknesses to assure that the anticipated aircraft loads can be supported during landing and parking (Barthelmy 1992).

At the Pegasus runway, initial coring revealed two very distinct ice types and several discontinuities. The uppermost ice layer throughout parts of the region is glassy, bluish in color, and includes many parallel, long, cylindrical bubbles (Fig. 4). This ice suggests at least one cycle of melt/refreeze behavior. Ice samples from lower in the core are cloudy with a milky white hue (Fig. 5). The enclosed bubbles make up a larger volume fraction but are spherical in shape and range in size from 1 to about 5 mm. This ice is typical of glacial ice formed by natural consolidation of snow. In most cores, the contact between the two ice types is sharp but firmly bonded, but a thin gap was occasionally detected (by probing down in the core hole). This gap was about 5 mm thick and contained hoar (faceted) crystals on both surfaces. Examination of the ice cores in meltwater ice revealed that the ice contained many large cracks. The ice exhibited failure planes that suggested doming and radial (star-like) pattern surface fractures. These features are probably the result of natural processes (discussed later).

The results of unconfined compression tests on a few Pegasus runway ice core samples are shown in Figures 6 and 7 (more information can be found in Lang and Blaisdell, in prep.). Most of the core samples were not suitable for testing since the cores shattered during the coring process. Few specimens with adequate length for compressive tests were available. The tested samples were extracted at the south end of the runway. Unfortunately, this is not the location of the weakest meltwater ice.

Figure 6 shows the stress-strain curve from ice at a depth of 10.5–15.5 cm from the south end core; this is snow derived ice (i.e., glacial ice). The applied loading rate was 44.4 kN/s (10,000 lbf/s). This rate represents the approximate loading rate of a C-141 tire rolling at 1.7 km/hr (1 mph). The test temperature was -10°C . Figure 6 shows a clear linear relationship between stress and strain to failure. This is indicative of a brittle failure mode in the ice. The failure stress is approximately 10 MPa (1450 psi).

The test results in Figure 7 are for an ice sample located lower in the horizon (20–27 cm deep). Its failure strength is approximately one-third of the strength of the sample that was closer to the surface. This may be a result of grain size effect; grain size increased with depth at the south end of the runway. The larger grain size could account for the reduction in strength. Figure 7 also

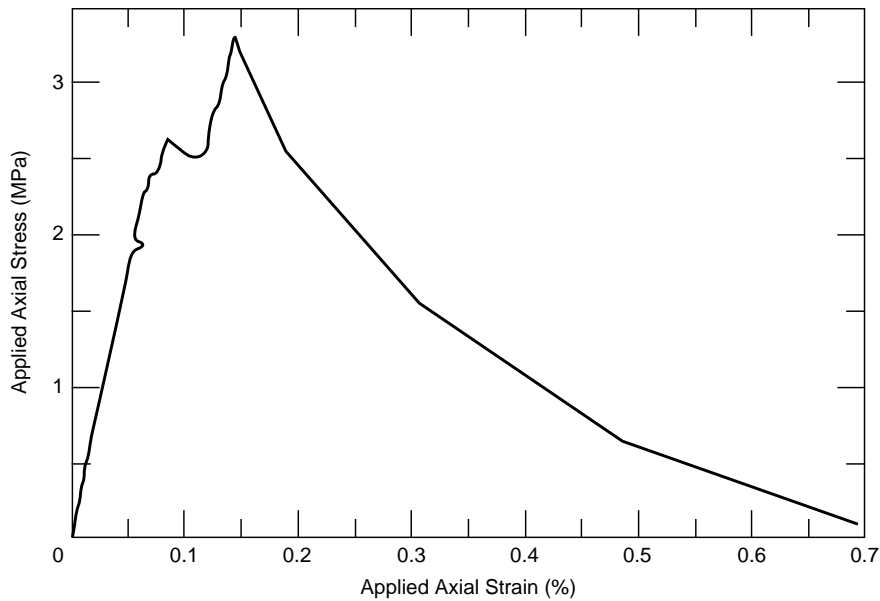

Figure 7. Stress–strain curve from ice at a depth of 20–27 cm, extracted at the south end of the runway (10,000 ft). Applied loading rate was 44.5 kN/s.

depicts a strong linear stress–strain relationship, verifying that brittle failure should be expected in this load and temperature regime.

The mechanical properties of freshwater ice depend on grain size, grain orientation, and grain type, temperature, strain rate, and loading rate. Typically it is reported in the literature that a decrease in ice temperature causes an increase in ice strength (Nuttall and Morgenstern 1972, Schulson 1990). Additionally, it is known that ice that is already internally damaged to some extent will continue to fracture more easily under a high applied loading rate as shown in fracture toughness tests reported by Hamza and Muggeridge (1979).

In-situ ice has a degree of confining due to the surrounding ice. The addition of a confining pressure should tend to shift the ductile to brittle transition towards higher strain rates (Kalifa et al. 1992), but at the strain rates of interest for rolling aircraft, no data are available. Schulson et al. (1991) show that at high confining ratios (the ratio of confining stress to the maximum normal stress is greater than 0.15), the fracture stress in the brittle failure regime does rise, but the dependence is not strong. At lower ratios there may be a marked increase in the fracture stress, up to three times the unconfined strength.

Recent research on other crystalline solids has clarified the effect of impurities on intercrystalline

bonds (Wu et al. 1994). Embrittlement of crystalline materials typically occurs at low temperatures and the addition of impurities plays a distinctive role in embrittlement, even if only trace amounts of the impurity are present. The energy required to break the bond with the impurity is less than the energy required to break a bond in the “pure” crystalline lattice. This effect would be augmented in ice due to the large bond energy of the hydrogen bonding in ice.

Relatively large quantities of impurities are present in the Pegasus ice at specific depths, due to storm winds delivering mineral dust and sand particles from Black Island. On a macroscopic scale when large particles are frozen into the ice the ice initially expands, squeezing the particle, and then contracts at temperatures less than -5°C . This could cause an entrained particle to debond from the ice structure and create a local stress concentration.

Thin-section analysis at Pegasus confirmed that the glassy ice at the surface of much of the runway was formed by freezing of water in contrast to snow densification. In many cases, large crystals could be seen (Fig. 8), indicating that freezing took place slowly under quasi-static conditions in the direction of the temperature gradient (similar to lake ice). Ice containing large, aligned crystals is often very brittle, and this could be detected easily by the manner in which samples broke

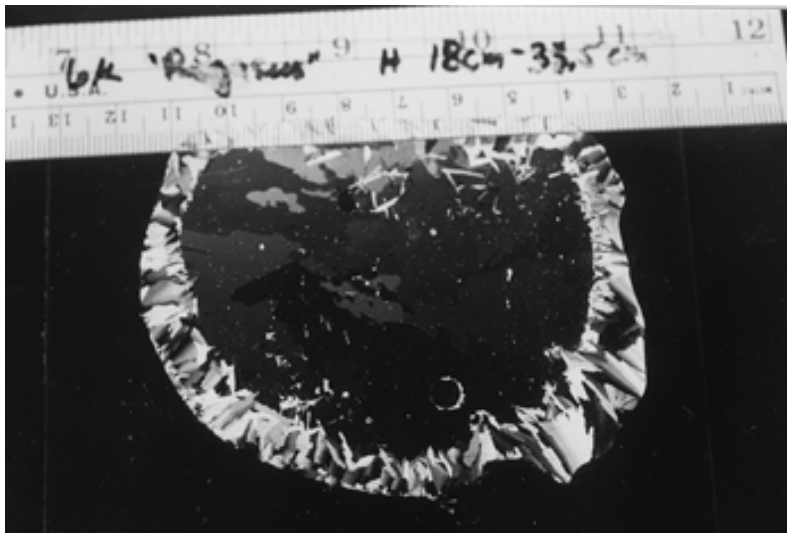

Figure 8. Thin section of typical melt/refreeze ice within glacier ice showing large crystals.

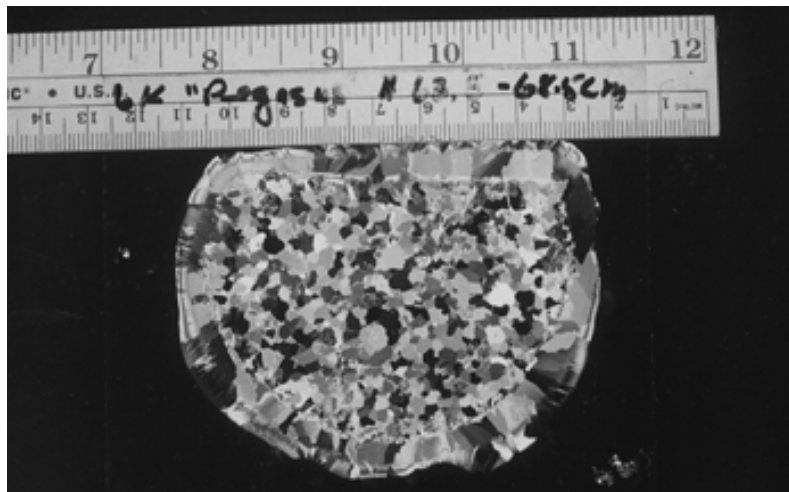

Figure 9. Thin section of milky glacial ice showing fine-grained texture.

when dropped. Thin sections of the milky ice were very typical of snow-derived ice; many small, randomly oriented crystals were visible (Fig. 9). It was anticipated that this ice would have greater strength and less brittle behavior.

Ice surface characteristics

No universally accepted criteria are available to determine allowable roughness for a runway. This topic is discussed by Gerardi (1978) and Sonnenburg (1978), but there seems to be no agreement as to whether passenger or aircraft accelerations should dictate limits to roughness. For

Pegasus, initial surveys provided a general topographic slope and evidence of long wavelength swales (Fig. 10). The surveys showed that a great deal of cutting would be necessary to produce a surface free of the large depression near the midlength of the runway. If this 300-m section could be filled (maximum fill depth of about 0.3 m) and if the runway was divided into three sections, each with a slightly different grade, a minimal amount of ice would need to be removed to achieve a very smooth surface.

Wavelength vs. amplitude analysis of the survey results was compared to U.S. MILSPECMIL-

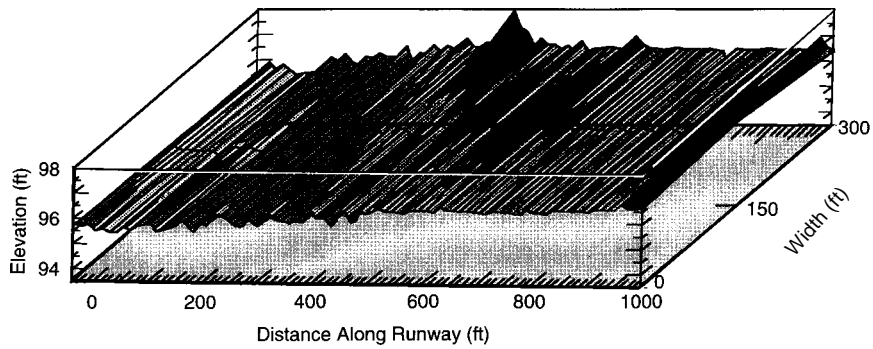

Figure 10. Three-dimensional contour map of natural ice surface at the site chosen for the Pegasus runway. Relative elevations given in feet referenced to assigned value of 100 ft for the base of the “Pegasus North” automatic weather station (AWS).

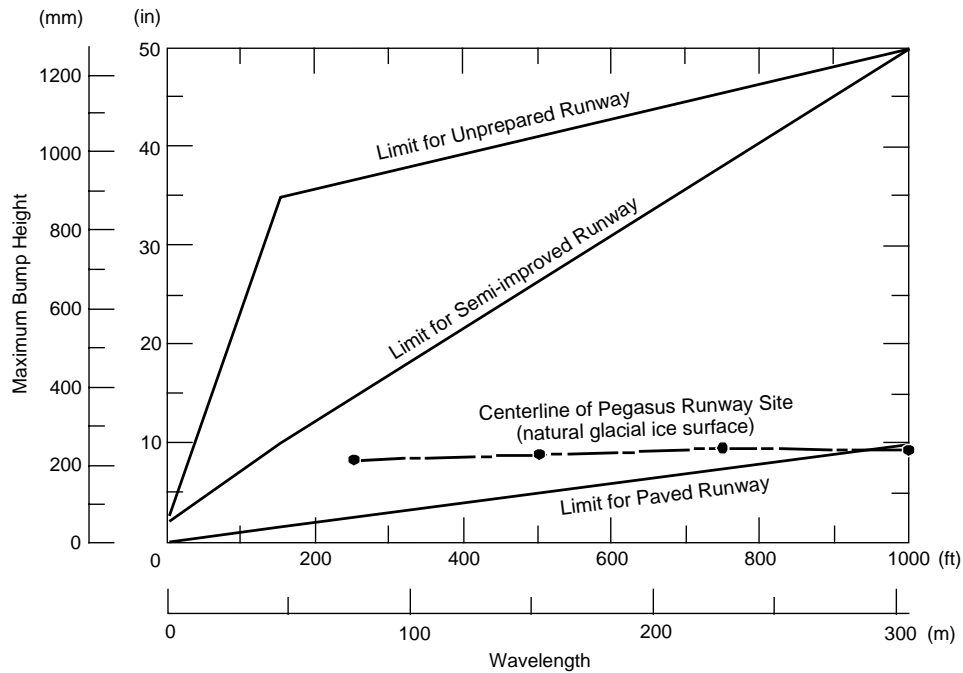

Figure 11. Bump analysis results for natural ice surface compared to military specifications for allowable bumps on runways.

A-8863B(AS) (Military Specification 1987) for allowable bumps, with the result that surprisingly little surface preparation would be necessary to meet open field requirements (Fig. 11). Our goal was to meet the most stringent bump guidelines to provide a safe, comfortable, and nondestructive (to aircraft) surface, and to immediately instill confidence in pilots upon their first arrival.

Snow depth, accumulation, and ablation

Little or no permanent snow cover is a prerequisite to a suitable site for a semipermanent gla-

cial ice runway. Anything more than about a meter of snow present on and around the site of the glacial ice runway will be problematic (principally from snowdrifting). Ideally, the site chosen should have no net snow depth change from year to year, although a process may be occurring whereby fresh snow is added at the top and balanced by some of the snowpack experiencing ablation or melting with subsequent evaporation or percolation and refreezing. A survey of the average snow cover over the ice (if any) will reveal if snow accumulation is a problem. As much as possible, the seasonal fluctuation in snow cover

depth must also be judged. If large quantities of snow are present at some times of the year but is nonexistent at other times, maintenance efforts may be substantial.

At sites with no snow cover, ablation may be a concern. Differential ice loss due to ablation may create unevenness in the runway surface and require patching or regrading. Runway support facilities (buildings, fuel tanks, runway markers) may become “perched” and unstable. The presence of ablation can often be seen where small snow patches have stuck to the ice or where rocks

or other foreign objects have lodged on the ice. The rate of ablation will be important to know, but is difficult to determine in a single visit. Comparison of major features seen in old airphotos or Landsat images with current observations may provide a clue.

If evidence of melt features is clearly seen at the site, a snow cover will be required to protect the ice during some portion of the year (when the air temperature and solar angle are highest). The site must have a readily available supply of snow at that time for this purpose.

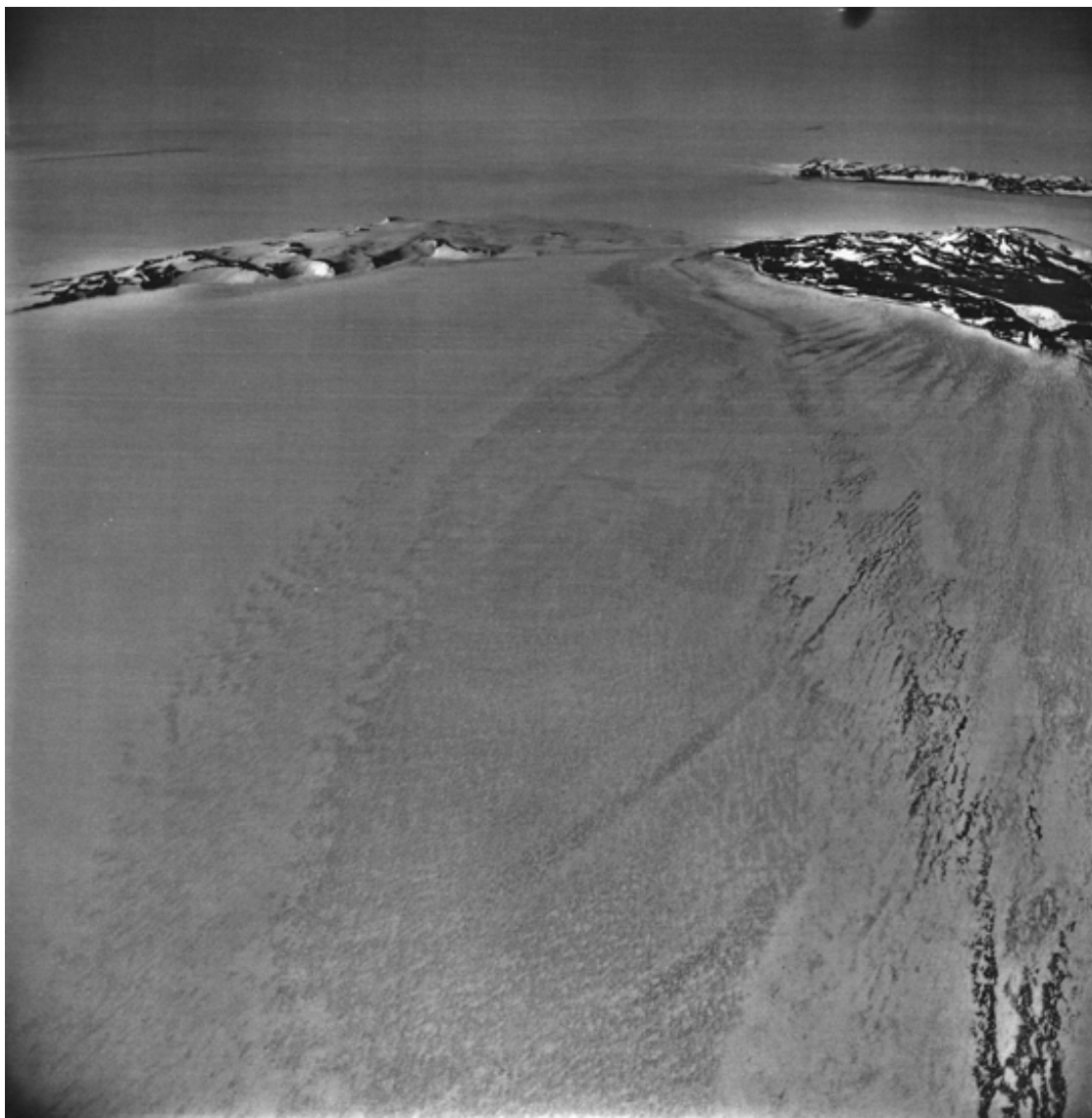

a. Photo taken in late January 1965 looking south (U.S. Navy for U.S. Geological Survey).

Figure 12. Airphotos of transition between zones of accumulation and ablation.



b. Photo taken in late January 1970 looking south (U.S. Navy for U.S. Geological Survey). Note airstrips of Outer Williams Field located just outside the zone of accumulation.

Figure 12 (cont'd). Airphotos of transition between zones of accumulation and ablation.

Observations and snow depth measurements over a two-year period in the region where Pegasus was eventually sited, combined with study of what little is written about Outer Williams Field, which existed in the mid-1960s (Huffman 1983, Paige 1968), and a review of historical airphotos suggested the presence of a near-constant snow cover averaging about 0.5 m (Mellor and Swithinbank 1989) (Fig. 12a and 12b). The Pegasus site is situated in a “transition zone” that lies between regions of accumulation and ablation (Swithinbank 1970). The snow cover in

the transition zone varies from local patches near the ablation region to over a meter where it phases into the accumulation zone. The Pegasus runway was sited just to the accumulation side of where the snow cover ceases to be patchy (Fig. 12c). It has an average natural snow cover of about 0.3 m.

Ablation in the region to the west of Pegasus is also a function of the dirt plume that extends from Black Island. The plume thins (lower volume of mineral particles) as it nears the Pegasus runway and the melt pool density decreases.

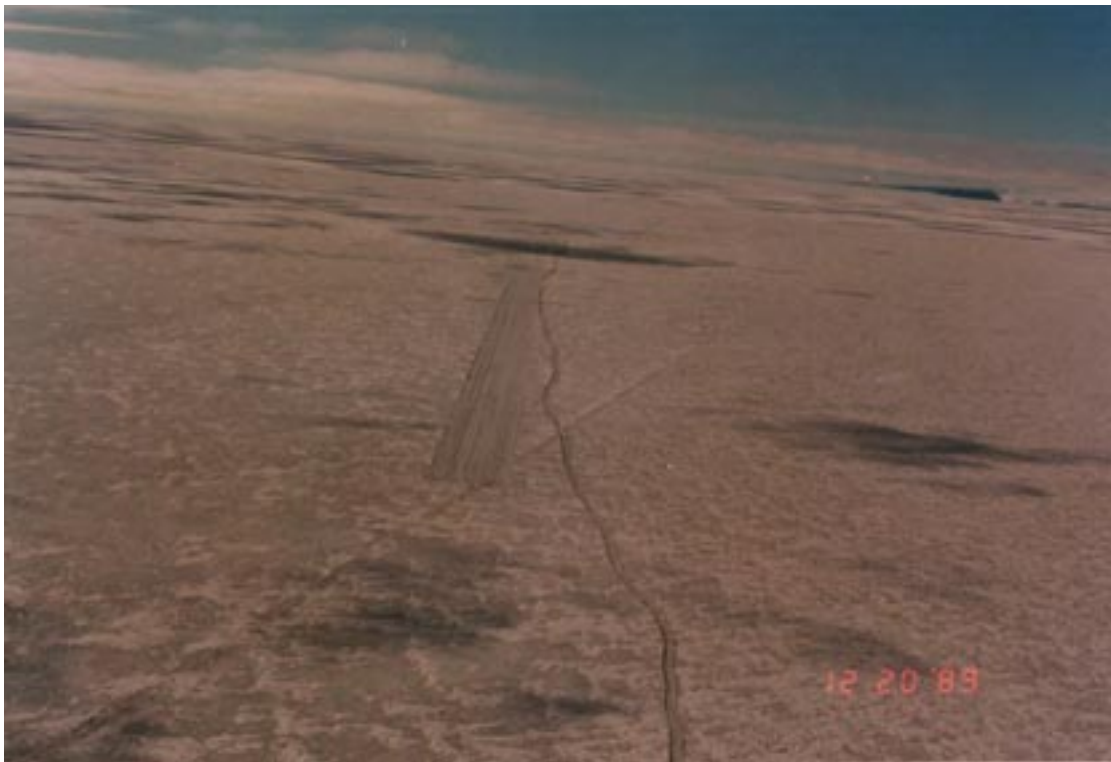

c. Looking north taken in December 1989 showing the initial Pegasus runway and areas of patchy snow to the west. The final Pegasus runway position is located just inside the accumulation zone about 150 m to the east of the airstrip seen here and about 2 km to the east of the former Outer Williams Field.

Figure 12 (cont'd).

Trend of accumulation/ ablation transition

In some cases, an ideal location for a glacial ice runway is in the transition between accumulation and ablation zones. The transition region is usually marked by a constant-depth snow cover. Often the transition zone is quite wide and it will have a directional trend. It may also shift slightly back and forth with variations in climatic conditions in any given year. The width and direction of the transition should be noted. These will have to be compared with the other site characteristics, such as distance from obstacles and prevailing wind direction, to assist in choosing an exact location for the runway.

At the Pegasus site, the transition zone is identified as a band about 2 km wide running approximately north-south. Its western extent is about 0.5 km east of the abandoned Constellation aircraft (named *Pegasus* and for which our site derived its name). The Pegasus runway is located approximately in the middle of the transition zone and is aligned roughly parallel to the borders

defining the transition zone (Blaisdell et al. 1995, Fig. 13). Runway placement was based on the eastern limit of essentially contiguous snow cover in late December (Fig. 14). Since the runway at Pegasus was specified to be a minimum of 3050 m (10,000 ft), the obvious choice for runway alignment was more or less parallel with the glaciological zones boundaries. To do otherwise would create a condition where each end of the runway would have very different maintenance needs. Fortunately, this choice of alignment coincided favorably with other factors (e.g., direction of most common destinations and strong wind direction).

Snow drifting

Indications of wind-driven snow movement at the Pegasus site include sastrugi on snow surfaces and small patches of snow stuck to an otherwise bare ice surface. At the site, the sastrugi are aligned in several directions. However, their long dimension is most often aligned with approximately 10° true. By contrast, the fuselage of the Constellation aircraft *Pegasus*, which is aligned

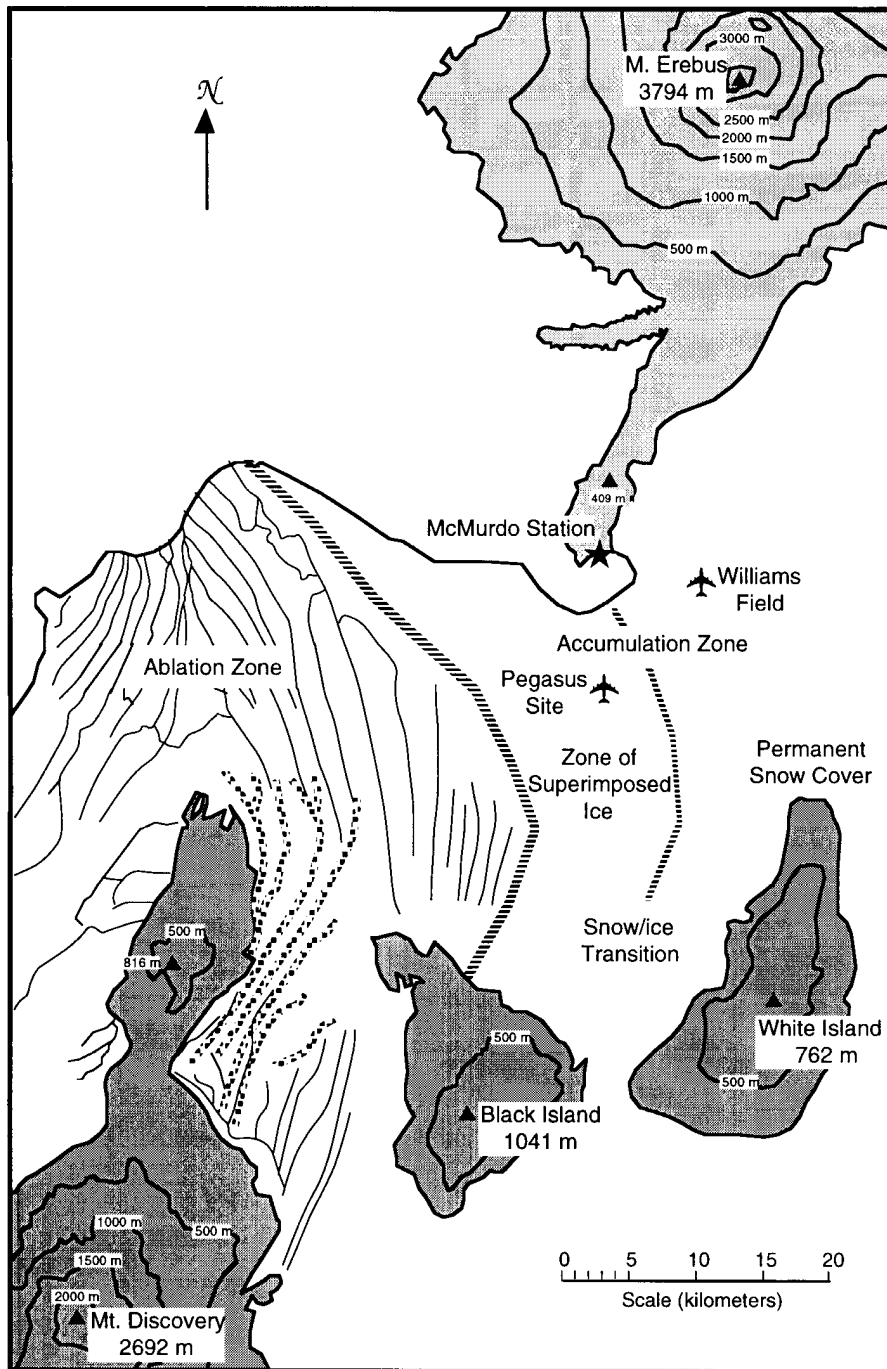

Figure 13. Location of Pegasus runway relative to regional glaciological zones.

roughly 330° true, has large parabolic drifts on either side. This suggests there is also snow movement in the east-west direction. After numerous site visits at various times of the year (except the austral winter) we determined that the storm winds from a general southerly direction carry a considerable amount of snow. Since it is moving so fast and with great force it is not prone to cause much drifting on level, relatively smooth terrain.

It can, though, produce immense drifts very quickly around objects that project above the level of the natural snow surface. This is particularly true of obstacles with a large dimension situated perpendicular to the wind.

At Pegasus, a great deal of snow also moves from east to west. This snow is carried by the gentle, but often present, easterly winds. Most of the snow cover for about 3 km to the east of



Figure 14. View to west of bare ice starting 250 m (800 ft) west of edge of Pegasus runway (December 1989).

Pegasus is firmly bonded to the subsurface. When loose snow is present after a snowfall during calm conditions (not an uncommon occurrence), this easterly wind can transport a great quantity of snow through the Pegasus site over the course of a day. Because the easterly wind is often low velocity, it is easy for snow to fall out of the wind column and be deposited. Since the runway is aligned perpendicular to the prevailing wind direction, large amounts of snow are easily collected if north-south aligned berms, windrows, or obstacles are present, particularly, along the east side of the runway.

Movement of glacier

From a single site visit, it will be difficult to determine the rate of glacial movement. If large or unique features are located near the runway site, it may be possible to use airphotos from the past to determine movement rate. Flow patterns on the glacier may also be apparent from photos, or from aerial reconnaissance. To accurately measure movement, GPS (global positioning system) markers should be appropriately located and monitored.

Movement of the Ross Ice Shelf edge directly

north of the old Outer Williams Field was measured by Paige (1966) and showed no westward movement. However, his description is not clear as to whether there is any movement in any other direction, except for the comment that a vast area of the ice shelf in the vicinity of Outer Williams Field is “apparently stagnant.” Swithinbank (1970) reports ice shelf movements in a northerly direction (287 and 296) at a rate of about 18 m/yr (60 ft/yr) at locations 8–10 km (5–6 miles) west-northwest of the Pegasus site. Measurements at the Pegasus site by the USGS in 1990, 1991, and 1992 indicate a westerly movement of about 40 m/yr (130 ft/yr) at the north end of the Pegasus runway, and about 42 m/yr (138 ft/yr) at the south end*. It is not obvious why there seems to be a 90° difference in ice movements reported within the Pegasus site vicinity.

Presence of contaminants

Any site considered for a glacial ice runway should be inspected closely for evidence of mineral contaminants. Ice cores may include mineral

* W. Tobiasson, CRREL, personal communication, 1995.



Figure 15. Mineral deposits in concentrated bands in ice.



Figure 16. Layers of wind-blown contamination in snow.

deposits (Fig. 15) and may indicate how frequently storms or events transporting mineral particles could be expected. If snow is present at the site, there may be bands of mineral dust stratified in the snowpack as evidence of wind-blown contamination (Fig. 16). Small amounts of dirt can lead to serious runway maintenance problems in a given season.

Mineral contaminants periodically invade the Pegasus site via strong winds. Aerial inspection of the site suggests that Black Island is the source and that strong winds from a south-southwest direction are responsible for their transport. In its current position, the Pegasus runway experiences minimal impact from dirt storms. Both ground, air, and core surveys in the area suggest that the runway is ideally situated with regard to minimizing contamination from this source. From areal observation in December, large plumes of dark mineral particles can be seen to cover much of the snow up to just short of the runway. A longer plume extends past the south end of the runway and detrimentally affects a 2-km section of the snow road from Williams Field about 2 km east of the Pegasus site. In December and January the snow surface in this area differentially ablates

and creates a “badlands”-like topography (Fig. 17). This trend is apparently quite stable; the effect of the dirt plume on the snow road was reported in the 1960s when Outer Williams Field operated.

Layers of mineral particles are apparent in concentrated bands at several levels within the ice of the runway. Since these bands are at some depth in the ice and the ice shelf is moving, they represent contamination events that occurred at an upstream location. Dirty layers can also be seen in the snow and were prevalent in parts of the topmost layers of ice that were graded during construction of the runway. In addition, during the past three years while working at the site we have witnessed mineral particles migrating through the site during storms. At these times, sand was transported across the snow surface via saltation and particles often concentrated and were trapped by small but sharp surface features in the snow (Fig. 18).

Flight plate

Prevailing wind direction is the most important aspect of runway alignment for most airport planners. Most localities with historical meteorological



Figure 17. Rotted snow surface resulting from differential ablation brought on by localized concentrations of mineral particles deposited by wind.

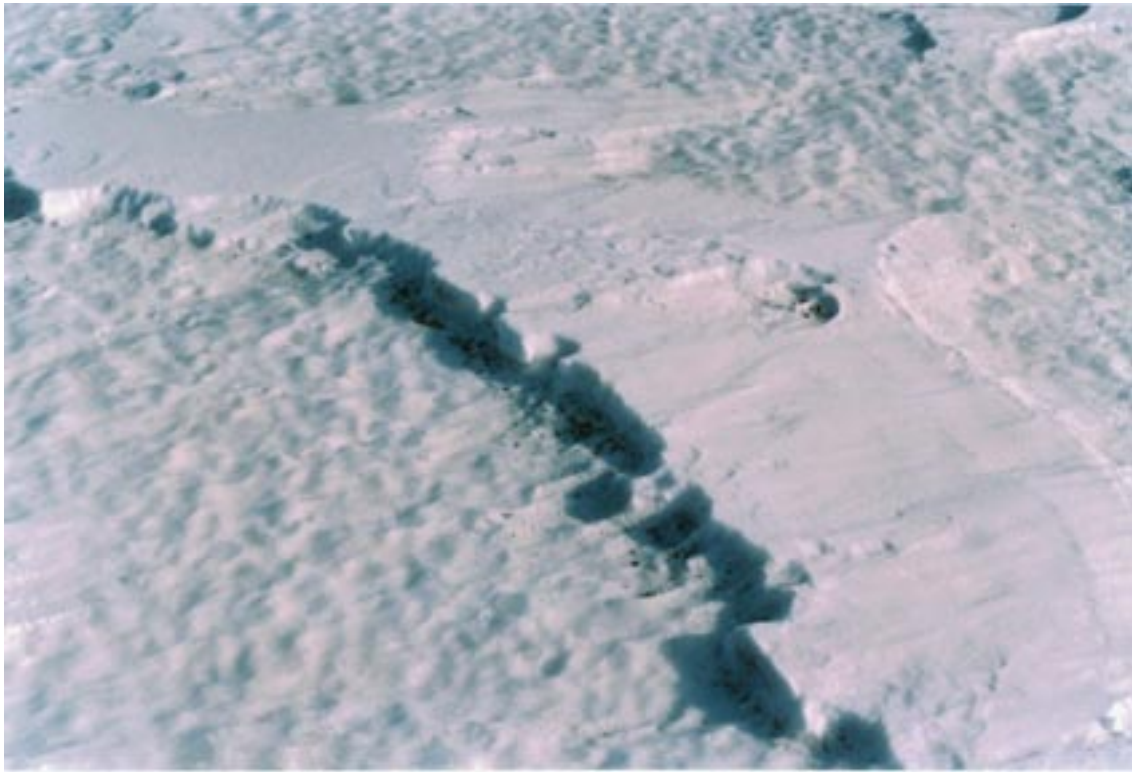

Figure 18. Moving sand trapped in sharp surface features on snow surface.



Figure 19. Gap between Black and White Islands (south heading of runway).

logical data can identify a predominant wind direction for the majority of normal conditions and for storms or high wind circumstances. Since the sites considered for a glacial ice runway will most likely not be in areas where suitable weather records are kept, a weather station will need to be installed, or indirect evidence of winds will need to be used. It is mandatory that at least a year of wind speed and wind direction data be collected for any site of interest, in particular during the time of year most likely for aircraft operations. These data will assist greatly in choosing runway alignment.

Obstructions are another major factor for consideration in alignment of runways. Mountains are the most obvious type of obstacle encountered. Minimum climb out and glide slope requirements for the design aircraft will dictate the zone of acceptable air traffic and thus the runway headings. Besides the usual precautions concerning obstacles as accounted for with minimum glide slopes and climb-out gradients, the site specific katabatic winds (gravitational/thermal winds) that often occur in regions of exposed glacial ice should be considered.

At the Pegasus site the prevailing wind is from the east at approximately 1.1–2.4 m/s (2.5–5.5 mph) and the strong (storm) wind from the south at approximately 11–23 m/s (25–50 mph) (Keller et al. 1995). In the development of the Pegasus runway, there were not resources available to construct two runways of 3050 m to accommodate both wind directions. With this constraint, and noting that the glaciological conditions at the site favored a north-south trending runway, we elected to align the runway with the strong wind direction.

To the south, the selected runway alignment aims toward the gap between Black and White Islands (Fig. 19). The runway headings are designated 34 and 16 (true headings). The first rise above the ice shelf to the south is 26 km distant and is about 250 m high along the vector of the runway. To the north, there is only level ice and/or water for a significant distance.

Logistical suitability

Any site considered for an airfield must allow reasonable accessibility to the camp or establishment that the runway supports. Suitable surface traffic routes to and from the runway should be identified, and their length and the terrain encountered must be carefully considered. These issues will need to be compared with the assets

available (vehicle types) and the nature in which the runway will be used. For instance, if the glacial ice runway will be used for daily operations, the establishment and runway should be situated close to each other and the connector route will need to be durable and fairly easily traveled.

There will need to be a large area adjacent to the glacial ice runway that can support parked aircraft for loading, unloading, fueling, and maintenance. These ramp areas should be viewed as expendable, since contaminants such as exhaust soot, fuel and lubricant leaks, and melt due to aircraft and vehicle engines will degraded the ice surface. They must be situated within easy access of the runway, but they may, in time, become degraded to the point where they will need to be abandoned. Ideally, there should be several locations where a ramp area could be situated, so that when one is discarded another can be employed without losing the runway facility.

The nature of the aircraft payload may also influence siting of the glacial ice runway. If only passengers, personal luggage, and small scientific instruments are to be delivered to the site, essentially no cargo handling equipment will be required at the runway and transportation to the main camp will be straightforward. However, if building modules or other heavy and/or bulky cargo will regularly be ferried to or from the airport, the ramp areas must be able to support aircraft unloading equipment (e.g., loaders, Fig. 20) and there must be suitable areas for staging and stockpiling cargo.

Access for construction

Site selection may also be influenced greatly by the ability to get runway construction equipment and facilities to the site. Most potential sites are likely to be remote and the logistics of the initial deliveries will need to be considered carefully. Overland traverse will be the most economical in most cases, but it may not be feasible due to crevasse fields, soft snow conditions, large distances, or prohibitive terrain between the site and the nearest trailhead. It may be possible to airlift with heavy-lift helicopters the necessary equipment, but this may seriously limit the size of equipment used or require major disassembly of some pieces.

Another potential option is to first establish a skiway on snow fields near the glacial ice runway site. The skiway may require some grooming or could be situated where minimal roughness and long-wavelength bumps exist. This runway would



Figure 20. Wheeled loader.

be utilized by ski-equipped cargo aircraft, like the LC-130 Hercules operated by the U.S. Navy VXE-6 squadron and the New York Air National Guard. If firm snow conditions prevail, cargo aircraft with low tire pressures (e.g., Ilyushin 76) may also be utilized. These aircraft would then deliver the equipment and building materials necessary to set up camp and begin runway construction.

At the Pegasus site, a snow road was established entirely on the ice shelf from Williams Field (Fig. 2). This road was flagged shortly after the site became of interest and each year it is compacted, groomed, and carefully maintained throughout the austral summer season. The majority of equipment used at Pegasus has its support base at Williams Field; thus this road constitutes the primary access to the site. When the sea ice is present and capable of supporting vehicle traffic, access may also be available via an annual snow/ice road directly connecting McMurdo and Pegasus (Fig. 2).

ESTABLISHING A DATABASE

After a review of the all of their physical properties, the remaining attractive glacial ice runway

sites will require further study to establish the response of certain characteristics over time, especially during the period when the runway would typically be in use. We recommend that the site be monitored through at least one summer season, preferably throughout an entire year. If historical records are available for the site or somewhere similar and nearby, they should be consulted. In general, the more data gathered, the more likely one will be to gain an accurate picture of the site characteristics. This will lead to an informed decision about the ultimate suitability of the site to support the type and volume of air traffic desired. We studied the Pegasus site for a total of three years (not continuously) prior to the onset of construction.

We strongly advocate the use of modern, self-contained data acquisition systems for collecting critical time-variable information. Sampling rates of once per hour are recommended; one data point per day can provide a general picture of the site, but this is too infrequent to be of much value.

Weather characteristics

The most important features to establish are the wind speed and direction throughout the desired operating windows. This information will

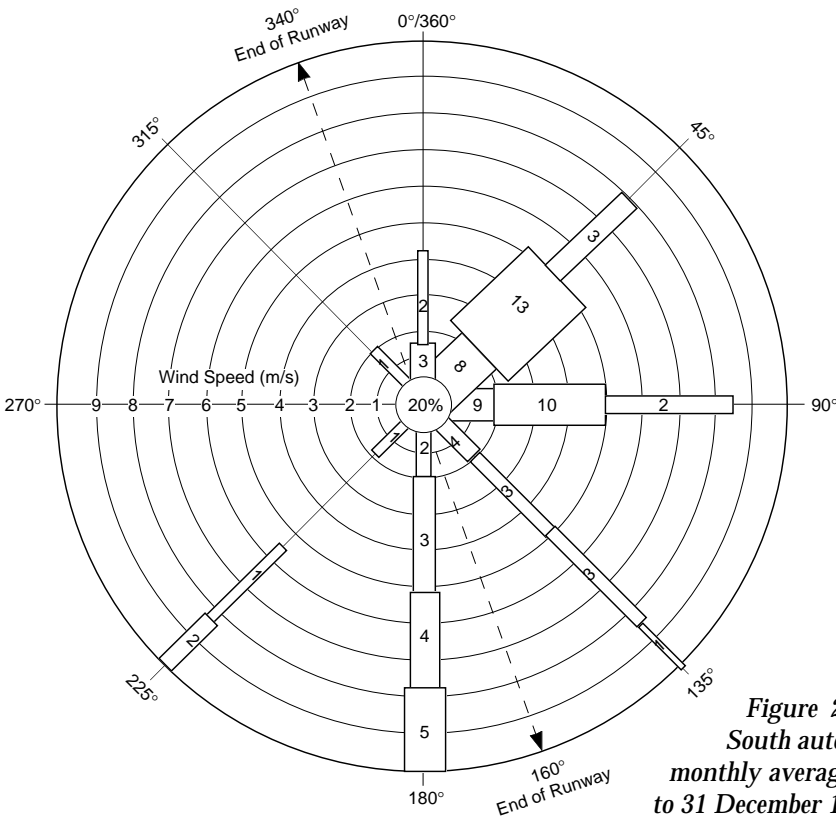

Figure 21. Wind diagrams for the Pegasus South automated weather station (AWS) using monthly average data for the period 1 January 1993 to 31 December 1994.

be necessary to establish the runway flight plate and will suggest the most amenable operating windows for safe aircraft movement. Wind diagrams such as shown in Figure 21 should be used to select the alignment of the runway. If only one runway direction will be chosen, it should align either with the strong wind direction (if strong winds are frequent and any other winds are fairly low speed) or with the prevailing wind direction (if it is of moderate speed and strong winds are infrequent).

Additional weather information may also be critical, such as air temperature, net radiation (incoming and reflected), cloud ceiling and visibility. The former two characteristics are important in predicting the integrity of the glacial ice and in estimating the probability of melt problems. The latter two factors will be used, together with maps of the regional topography and desired aircraft characteristics, to establish minimum safe operating conditions. The weather data gathered at this step of the process will allow the probable number of flight days to be determined.

The most convenient means of establishing these data is to install an automated weather station (AWS) at the site (Fig. 22). Reliable AWSs now exist and can be monitored via satellite

transmission of data (Keller 1995). They can be configured for a variety of measurement interests. At the Pegasus site, two AWSs were installed in 1991. Data from these monitors, and others on the Ross Ice Shelf, have been studied with the aim of establishing weather forecasting methodologies for the aircraft operations on the runway (Holmes 1995). Additional analyses of wind data from the Pegasus AWS are contained in Appendix A and resulted in providing the trends shown in Figure 21.

If AWSs are not available, traditional methods of data gathering may also be used, where individual recording units are installed at the site for each factor of interest. They will need to be accessed periodically to retrieve data.

Ice temperature profile

Ice temperature profiles are the most important ice information because the mechanical behavior of ice subjected to loading is strongly influenced by its temperature. Vital information is the maximum temperature, particularly during the time period the runways would operate, and its location within the ice column. Subsurface melting may not always be obvious, but it could easily be disastrous for wheeled traffic (Fig. 23). If tem-

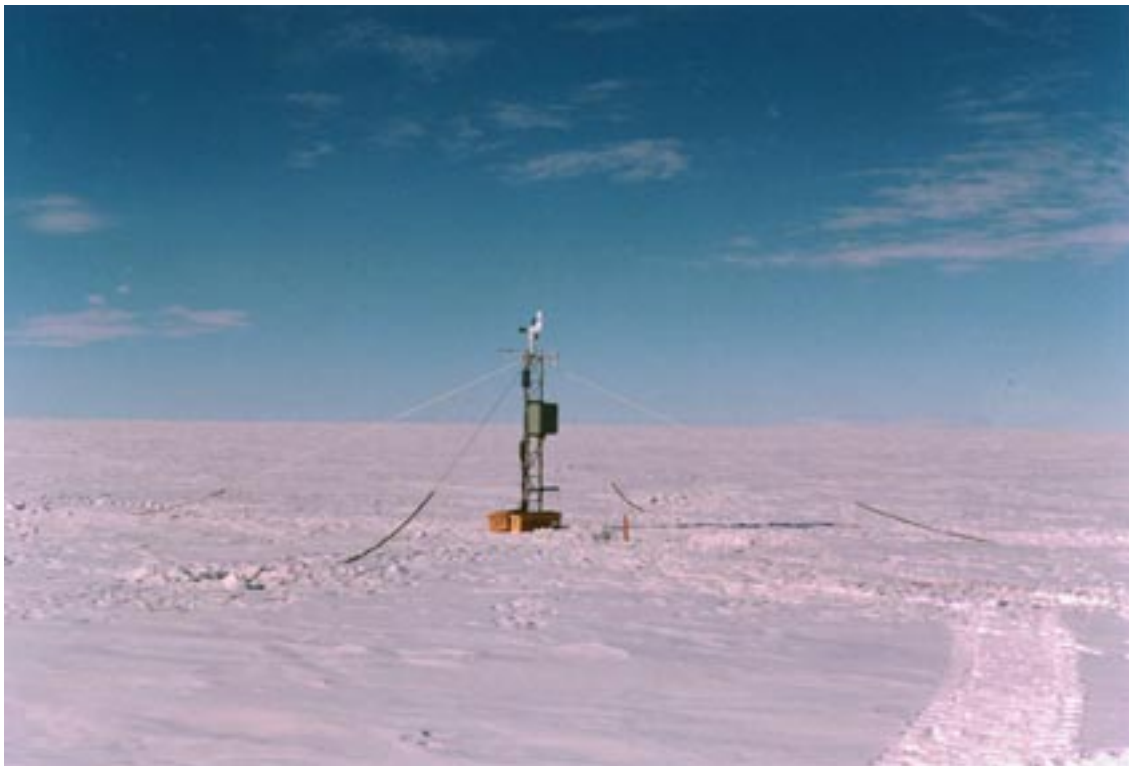

Figure 22. Automatic weather station installed at the Pegasus site.



Figure 23. Grader tracks showing breakthrough of thin ice cover over subsurface melt pool.

peratures reach near the melting point at any level, melt features and their commensurate problems may be an issue at the site. Even if no melt features are apparent at the site in its natural condition, if the ice temperature profile shows values over -10°C at any time during the season, the effect of construction may change the site enough to allow melt features to develop in the heat of the summer.

Thermocouple or thermistor strings are the easiest means of monitoring the ice temperature profile for long time periods. At the Pegasus site, we used Cu-Co thermocouple strings with sensors located at 1 cm above the natural ice surface, and at distances below the ice surface of 1, 5, 10, 25, 50, 75, and 100 cm. We completely enclosed the thermocouple strands in a single segment of heat shrink tubing. The leads and housing extended for 1.5 m beyond the top of the ice surface. Installation of the thermocouple strings was completed by hand-auguring a 5-cm-diam. vertical hole in the ice, inserting the string, and backfilling the hole with snow, followed by slow filling with cold fresh water. Once the thermocouple string was frozen-in, the lead was run along the ice surface 1.5 m away from the hole and connected to a weather-tight box containing a Campbell Scientific data acquisition system. We covered the thermocouple lead and the data logger box with snow to protect it from excessive solar heating.

Temperature sensor strings should be placed at locations in the area where it is most likely the runway would be sited. It may also be wise to install a string in the ice in any areas within the locale that have distinctive characteristics (e.g., bare and snow-covered ice, in obvious melt features). The goal should be to get a representative picture of the range of ice temperature regimes within the area of potential runway siting.

It should be recognized that the presence of the thermocouple string will alter the thermal regime of the ice at that spot, but, if properly installed, solar effects can be minimized.

Solar radiation

In areas where the air temperature reaches or nears the melting point, the effect of solar radiation will need to be well understood. Of primary importance is the potential for radiation to be absorbed into the ice and act as a heat source at some depth in the ice (Brandt and Warren 1993). With air temperatures near, but often below, freezing and intense sun, the near-surface ice may heat to the point of melting at certain times of the year.

These melt features may never reach the ice surface (always retaining a thin ice cover) but they still may be deep and massive in extent.

Radiometers are the best tool for measurement of solar radiation. A number of varieties exist; it is best to use a model that records input from an entire hemisphere (half-globe), since most glacial ice sites are located at high latitudes where the sun angle will be low, but a large portion of the horizon can be swept by the sun. The radiometer used should be capable of measuring radiation within the wavelength range from 0.3–100 μm .

We advocate installing radiometers in pairs, one facing straight up (base plane parallel to the ice surface) and the other directly toward the ice surface. The pair should be held about 1 m above the ice surface by a secure system that has set-back leg(s) that cast little or no shadow within a 3-m radius of the centerline of the radiometers. By using radiometer pairs in this manner, one can determine the total incoming radiation, the amount reflected from the terrain surface, and the net absorbed radiation (the latter is the difference between the two measured values). Radiometer pair measurements should be taken over each surface type to gain a clear picture of the amount of absorbed radiation over bare and snow-covered ice, and in areas where natural contaminants exist (e.g., mineral dust, incorporated rocks). These data will be valuable in assessing whether melt will be a problem, whether natural materials can be used to minimize or eliminate melting, and if certain localities within the region are less problematic and thus more suitable from the outset.

We feel that it is best to take radiometer measurements very near the sites where ice temperature profiles are being monitored. This allows a good understanding of the site-specific balance of air temperature, solar input, and ice temperature response. Unfortunately, radiometers are usually very expensive. This may limit the number that can be placed in the field. If regular site visits are feasible, a single radiometer pair could be used to continuously record data at a single location at the site, but, upon each visit, the radiometers could be moved around to each ice temperature measurement site to obtain at least a series of single-point correlations.

At the Pegasus site, we used Eppley pyranometers on several occasions during the peak of the austral summer. Unfortunately, we have never had the opportunity to connect them to a data acquisition system and thus only have spot readings. We used a tripod system for mounting the

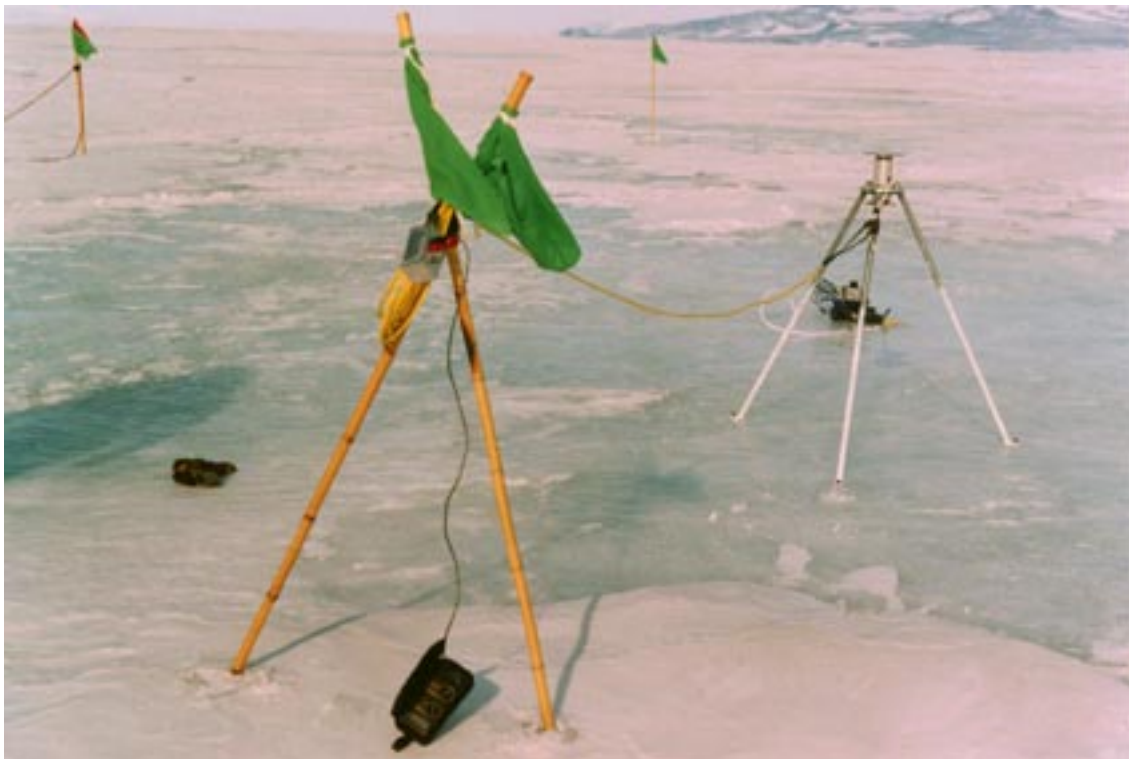

Figure 24. Radiometer pair used to measure albedo of snow and ice surfaces.

radiometer pairs (Fig. 24) and took measurements over snow-covered ice, exposed ice, snow with incorporated mineral dust, and worked snow (graded and/or snow processed with the snow-blower). We measured pyranometer output in volts and recorded only the relative difference in reading among the different sites and for the incoming vs. reflected globes.

Topography and ice movement

During the first site visit, the topography of characteristic segments of probable runway positions should have been determined by surveying. It is unlikely that the topography changes much over the course of a year unless the glacier is moving quickly. However, it may be wise to re-survey one or two segments at significant time intervals (e.g., 12 months).

More important will be to ascertain the overall movement of the glacier in the region of interest. Benchmarks of some sort should be established at several locations within the site of potential runway positioning. These may be very simple in nature, such as a wooden post or plastic pipe buried to a depth of say 1 m and extending above the terrain surface about 0.25 m. If the site has any potential for melt problems, the ice for some area around the benchmark should be covered with a protective snow cover. The goal is to establish a marker that will move with the glacier but will not experience any change in attitude relative to the immediate surrounding ice.

The benchmarks should be exactly located at several times over the course of site observation to establish rate and direction of movement. Locating the benchmarks may be done either using GPS or by traditional surveying from a known fixed point (nearby rock exposure).

If cracks or crevasses exist within the region of interest, they too should be monitored for movement. This can be accomplished by sketching and measuring attributes of the features (width, depth, directional orientation, attitude of subsurface planes) and by surveying-in (from the benchmarks) key features of the crack (e.g., its ends or an offset or crack intersection point). Measuring crack position and movement frequently during the site observation period would be ideal to determine if the crack has active and dormant phases. The farther the cracks are from the most likely runway position, the less attention they need to receive.

Data analysis

The data collected should be analyzed and stored to establish a historical record of the site characteristics. In addition, the data should be compared to the desired operating scenario (aircraft, flight season, cargo demands) to ascertain the suitability and the limitations that will be posed by the chosen site. Clearly, one year's record will most likely not portray the range of conditions that can occur at the site. Thus, it is valuable to compare the new data with any historical records or accounts of the site, or to collect data for several years. It is the goal to determine what is the range of temperature, wind and ice behavior at the site and to ensure that its properties are either compatible with the planned use or can be managed to yield a suitable facility.

Temperature (air and ice), wind speed, and radiation data should be manipulated to produce plots of variation with time over the span of the season during the period of planned runway use. The plots should be scrutinized in any areas where the temperatures approach the melting point to determine the extent of time that could be problematic and the amount of temperature modification that will be necessary on the runway to ensure prohibition of melt features. Lateral ice movement rates and elevation changes should be determined and plotted on maps to project the life expectancy of the runway and to predict the amount of work that will be necessary on a seasonal basis to keep the runway level within the standards for the aircraft to be used.

These data will also be vital in planning the construction process. The extent and timing of each window of opportunity can be identified from these data and decisions about equipment needs and single vs. multiyear construction schedule can be made by matching the tasks to be accomplished to the time available at the site.

Making site selection

It is unlikely that a site with no drawbacks will be identified. However, armed with the data and knowledge of the task and the potential sites, a rational decision can be made as to the best site for a glacial ice runway. Development procedures, equipment needs, and construction schedule will most likely be different for any one of the potential sites. Based on the available resources, the timetable for operations, and the compromises necessary for each site, a satisfactory choice can

usually be made. In some cases, it may be necessary to change the initial vision of the operation to match what is feasible to develop in the field. And, possibly, the data will show that it is impossible, not economic, or foolhardy to choose any of the potential sites.

The initial runway at the Pegasus site had its north end at 77°57'S, 166°30'E and its south end at 77°59'S, 166°34'E in 1990. The elevation was determined to be 8.8 m (29 ft) above MSL. The final runway was constructed parallel to this axis, 150 m (500 ft) to the east. The position of the centerline of the runway in 1995 was 77°57'18"S, 166°30'53"E (north threshold) and 77°58'51"S, 166°33'34"E (south threshold).

ENVIRONMENTAL IMPACT EVALUATION

Laws governing development are certain to exist in most areas where a glacial ice runway could be considered. Before construction, and perhaps during site investigation, it is important to learn what laws and procedures must be met before the selected site can be modified. An important advantage of a glacial ice runway is its use of natural materials and the small degree to which the terrain is changed. Glaciers and ice shelves are often located in pristine settings that have high esthetic value. Thus, it is wise to know in advance what regulations and conditions must

be met to proceed with construction. In most cases, an environmental impact assessment will be required. In the event that one is not required, we still recommend that such a document be prepared. The process of writing such an evaluation helps greatly to focus ones overall approach and can be very valuable, should there be a challenge to the project after construction begins or the runway is in operation.

Although Antarctica is not a country and therefore has no "laws" to govern the activities of humans, a number of guidelines are in place to address development. For some time there has been cooperation among the national Antarctic operators to establish ethical and responsible protocol for activities on the continent. Private parties visiting Antarctica are also encouraged to adhere to these guidelines. While these guidelines are nonbinding, they have arisen primarily for the long-term preservation of the continent.

In addition to the cooperative international agreements for activities in Antarctica, some countries governments have enacted laws governing the actions of their citizens while in the Antarctic. Prior to construction of a glacial ice runway in Antarctica, an operator should consult their national laws, the Antarctic Treaty, and the Protocol on Environmental Protection of the Antarctic Treaty (Madrid Protocol). For the Pegasus runway, the National Science Foundation prepared an initial environmental evaluation (App. B).

CHAPTER 3. CONSTRUCTION

Many disciplines will be involved throughout the process of developing a glacial ice runway for heavy wheeled aircraft. Although the needs or desires of each specialty will occasionally conflict, each facet in the development and operation of an airfield must be smoothly coordinated. In many cases this will involve compromise. To ensure that the resulting facility is safe and efficient, we recommend that a management team be assembled as the first step in construction of a glacial ice runway and that the team continue to work closely together, at least until the runway is operational. One or two key members should probably participate in the site selection process to provide perspective on the equipment and construction needs associated with each potential site. In some cases, the management team may continue to operate well into the life of the runway when maintenance and operational patterns are well established and preservation techniques for the facility are routine knowledge.

The critical team members would include specialists in three areas: snow and ice science, snow and ice construction, and engineering with airfield experience. It is important that the individuals selected be willing to work together as a team. Their initial task will be to establish a construction plan to meet the desired timetable and to ensure that the glacial ice runway produced meets the required performance standards. The foremost design parameter will be the characteristics of the aircraft to be operated from the facility. From there, the management team must develop and share a common goal for the ice airfield.

Additional staff will be added as the project unfolds. Being experimental, the Pegasus runway project began with one individual who covered most of the specialist roles and for brief intervals of time was also a heavy equipment operator. It wasn't until the third and fourth years of the project (when the scope of work became clearly defined and necessary equipment was procured) that a full-time staff was utilized. This full-time staff included a field engineer/project manager, a snow and ice scientist/engineer/instrumentation expert, three snow and ice construction specialists, and a fabricator/mechanic/machinist, with periodic access to a general mechanic and several equipment operators. All of the full-time staff, except for one individual, had significant prior polar (mostly Antarctic) experience, and all of the operators and mechanics also had specialty con-

struction experience from the temperate world.

The construction process should be followed in a more or less sequential fashion as listed below; however, the size of the runway, the physical and environmental conditions at the selected site, and the resources available may dictate a multiyear construction effort. If several years are required to build the facility, it is probably best to complete the entire construction process for individual segments of the runway that are manageable in a single season. This process would then be repeated for as many seasons as required to finish the facility.

The construction schedule and equipment chosen will dictate the staff needed to build the runway. We recommend that all of the staff be versatile, with not only specialized skills but with demonstrated abilities and interest in a variety of related fields. For example, it is always wise to choose equipment operators with a mechanic's appreciation, since they will take better care of their equipment and will, in many cases, be able to troubleshoot and do repairs themselves.

SITE DEVELOPMENT

As soon as the decision is made to build a glacial ice runway at a particular site, the management team should review all of the data and information about the site. From this, the scope of the construction project can be determined and equipment and labor estimates can be made. As soon as possible, equipment needs should be determined and orders placed for items that will require modification or extensive preparation, or for equipment that is not commercially available and will need to be fabricated. The type of equipment required will depend heavily on the site chosen (depth of snow present, roughness of ice, distance from established lines of communication) and the available means for transportation to the site (airlift, overland).

A preliminary airport design should be developed. In most cases, this design should be as simple as possible, with the recognition that once construction begins, there may be conditions that require the design to be modified. There may be benefit in loosely adhering to conventional airport design principles (Federal Aviation Administration 1989) to minimize confusion for pilots,

air traffic controllers, and others who may use the facility and have prior experience only with typical airfields.

An initial construction schedule should be made with input from equipment operators and from the facility managers. This schedule must be realistic and take into account the length and timing of environmental windows of opportunity for certain operations, the state of the equipment to be used, the general and specialized (snow and ice) training of the equipment operators, loss of efficiency when operating at extreme temperatures, and the ability to deal with inevitable mechanical breakdowns (shop facilities, backup equipment). A multiyear effort will almost always be warranted for runways that will support heavy aircraft. In a multiyear plan, the size and sequence of sections to be prepared should be determined in advance. There is wisdom in choosing the least challenging section for the first season of construction to allow for time to learn the equipment and operators' limits and capabilities and to establish what is a reasonable work schedule.

The construction schedule will be modified and refined as site development proceeds. At all times this schedule should include every possible detail

including the phasing of the project (time and geography), equipment, and staff needs for each task, fuel requirements, mechanical support, and subsistence needs. In addition, contingency plans should be considered for breakdowns in equipment and for unexpected weather or ice conditions. The more thought that is brought to bear on creation of the construction plan, the more efficient and economical will be the actual runway construction. This may seem obvious, but we often fail to grasp the brevity of critical environmental operating windows, or of the entire summer season for that matter. What would be a very small perturbation in a construction schedule in the temperate world is often a one-year delay in polar environments.

Facilities

Any site, whether easily accessible or remote, will need support facilities before work can begin. We consider the essentials to include 1) a shelter sized for the typical on-site workforce, with cooking facilities, food storage, and lounging/eating space; 2) generator(s) for electric supply to the shelter and to power tools and vehicle heaters; 3) a tool, spare parts, and lubricants enclosure; 4) a latrine; and 5) a supply of fuel for the



Figure 25. Shelter for workers at Pegasus runway.

generators, equipment, and, in an emergency, 6) aircraft. At the Pegasus site, we utilized two small sled-mounted structures. One, the “chalet,” included a phone, table and chairs, sofa, water storage, countertop with portable stove, and shelves for storage of cookware, dishware and utensils, packaged food, and equipment and technical/scientific literature (Fig. 25). The other building served as a tool shed with some room for parts storage, and had a urine funnel attached to the wall and connected to a barrel outside (Fig. 26). A fold-up toilet was located in this building also. The tool shed did not take up the entire sled deck, and a self-contained 20-kW generator and fuel supply were mounted outside the building, sheltered with wooden covers. A sled-mounted 19,000-L (5000-gal.) tanker was on site to provide fuel storage and was placed on a bulldozed snow berm to allow gravity feed when fueling equipment. Our wastes, human and otherwise, were containerized on site and returned to McMurdo for processing.

The proximity to major support facilities (Williams Field and McMurdo) allowed the Pegasus runway camp to be small and efficient. (Morning and evening meals, potable water, berthing, and shops were provided out of Williams Field.) More

remote sites will require berthing and water production and perhaps waste treatment capabilities. They will also need to have more space allocated to food storage and personnel area (lounge), a larger tool and workshop area, and increased parts and supplies storage.

Access road

Because the Pegasus runway was developed by a “commuter” workforce, a great deal of time and effort was spent on snow road construction and maintenance (the 15-km, or 9-mi., road connected Pegasus to Williams Field). This is an entire separate topic (e.g., Abele 1990), and should be recognized as a key element in the utility of any runway that will be accessed frequently via overland transport. Sound road construction requires performing a sequence of operations, all linked closely with temperature, and subsequent immediate attention to maintenance needs when they present themselves. Generally, a well-constructed snow road will require only a small amount of periodic maintenance, if it is performed promptly. Storms naturally create problems for most roads, and small drifts can quickly amplify if they are not leveled as soon as possible.



Figure 26. Tool shed and latrine at Pegasus runway.

Initial open-up

At Pegasus, we took survey data along the entire length of the runway at 1-m (3-ft) spacing from the centerline and the east and west sides of the runway and generated a three-dimensional map of the runway surface (Fig. 10). We grossly exaggerated the vertical scale in this plot to amplify the unevenness of the ice surface to make the undulations more obvious. Clearly, removal of high-frequency bumps was the important task.

Natural snow cover averaged about 30 cm (12 in.) in late August on the proposed Pegasus runway. We planned for removal by stripping and loosening the snow using a large V-plow, followed by a high-capacity snow blower to remove the snow to the sides of the runway. In retrospect, we may have been able to take advantage of strong winds (which occur at specific times of the season) to assist in snow removal by loosing the snow and piling it in rows parallel to the wind direction. Use of this method requires a good understanding of the site and greater flexibility in terms of scheduling, since strong wind occurrences may be sporadic. It has the advantage of cleanly removing the snow far away from the site and, under the proper conditions, huge volumes of snow can be moved in a very short period of time.

We used a V-plow mounted to the front of a Caterpillar 14G grader equipped with oversize tires to make the first opening passes on the Pegasus runway (Fig. 27). There were certain drawbacks to this approach. The large amount of cutting edge on the ice, compared to the width of snow plowed, made the V-blade very susceptible to undulations in the ice surface. Thus, the blade had the tendency to leave a considerable amount of snow bonded to the ice. As the blade was mounted on the front of the grader, only a limited amount of down pressure could be exerted to assist in holding the blade in contact with the ice surface. Also, the blade was a considerable distance in front of the operator, and was large enough to be difficult to see over from any position. This made it difficult for the grader operator to finely control the blade and keep it in contact with the ice surface.

We also used an elderly Caterpillar LGP D8 equipped with a Balderson coal U-blade to strip the snow from the glacial ice surface (Fig. 28). At first the bulldozer operator worked by “feel,” attempting to hold the blade just at the snow/ice interface. Owing to the undulating ice surface and the need to provide some downforce on the blade to keep it from riding up in the snowpack, this often resulted in the blade gouging into the



Figure 27. Initial snow stripping on the Pegasus runway using a grader-mounted V-plow.

ice. To alleviate this situation, we built and equipped the blade with skids or feet that were sized to easily penetrate the snow to the ice surface, but with enough bearing surface to avoid damaging the ice (Fig. 29). Using the skids, it was easy for the bulldozer operator to find and grade along the snow/ice interface at significant speed.

We also attempted to use an angle bulldozer blade, but the tractor was always being pushed sideways. With the limited traction available on ice, it was very difficult to produce straight windrows. We also experienced the problem of finding and maintaining grade, but the skids were difficult to adapt to the angle blade.

One other option was to work the snow with a multitooth ripper mounted on the back of a Caterpillar D6 tractor. Initially, we had a problem with loosening the snow without gouging the ice, but the outside ripper teeth with “shoes” equipped proved to be very effective (Fig. 30). Subsequent addition of a float valve on the ripper hydraulic controls vastly improved performance and control. Passage of the ripper broke free most of the snow and left it in small, somewhat tumbled, slabs.

Ultimately, we found that the stock grader blade was most effective at peeling the snow free from the natural ice surface. Following the grader,

we used the D8 with a large capacity U-blade and skids to tumble the snow windrows produced by the grader, thus preparing the snow for removal. A huge mound of snow would build up in the blade and would ride up the curvature of the blade as the tractor moved forward at good speed. Upon reaching the top edge of the blade, the snow would smoothly roll forward in front of the blade to be re-ingested a few moments later. This repeated tumbling action broke up the hard, layered snow and mixed it into a homogeneous, loose mass of snow that would eventually pour out the sides of the blade, leaving two windrows.

To remove the snow from the runway area, we used an Oshkosh prime mover equipped with a Rolba snowblower (Fig. 31). The 2.6-m (8.5-ft)-wide, two-stage blower with a 1.5-m (4.8-ft)-diam. ribbon-style drum was mechanically driven (drive shaft). Separate motors powered the blower (300 kW or 400 hp) and the prime mover. The unit we used had four-wheel drive and four-wheel steering, the latter being unnecessary for our application. The blower was rated for 2720 tonnes/hr (3000 tons/hr) with a casting distance of 46 m (150 ft). The blower head was controllable for up and down (including down pressure), tilt forward and back, and casting direction (roughly 140° centered about the vertical with infinitely adjustable



Figure 28. Initial snow stripping on the Pegasus runway using a bulldozer with U-blade.



a. Skids installed on D6 bulldozer.

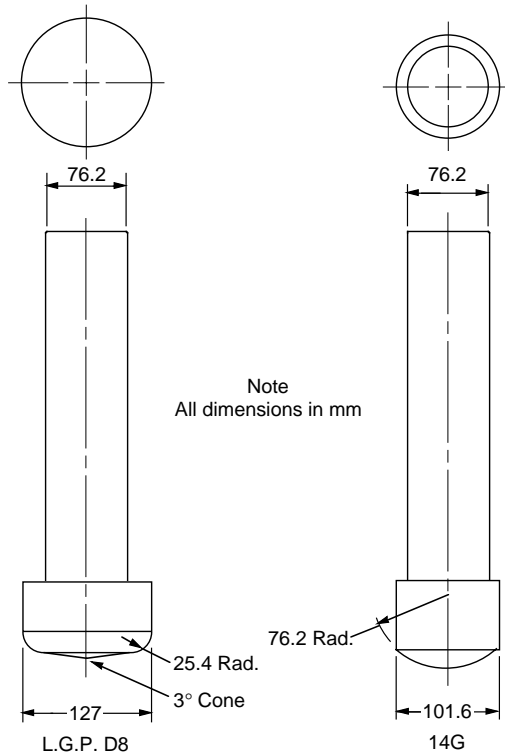

b. Sketch of dimensions of skids for bulldozers and for motor grader.

Figure 29. Adjustable skids used to hold equipment blades a fixed distance above the ice surface.

forward and backward casting deflection). The ability to have a wide range of control over casting is very important. It allows precise placement of debris and makes it possible to work when winds are from any direction. Side tilt of the blower was not present nor needed for our application.

An attempt was made to strip the snow directly from the ice surface with the snowblower. The problem of ice gouging, as experienced with the blades, was also found to exist for the cutting edge of the blower. We equipped the blower with skids similar to those for the bulldozer blade, and



Figure 30. Ripper equipped with skids on outer teeth.



Figure 31. Rolba ribbon-type snowblower mounted on Oshkosh truck.

this allowed the snow blower unit to do a fair job of stripping the ice. However, we found that the machine could not generate enough down pressure in many cases to adequately strip the snow from the ice. More importantly, the machine had to move very slowly and the volume of snow removed from the area per unit of time was very small compared to the rated capacity of the blower. Thus, it became obvious that the most efficient use of the snow blower was to “feed” it large mounds of loosened snow, where it could make reasonable forward speed while ingesting significant quantities of snow.

A similar lack of efficiency was found when the snowblower followed the ripper. Forward progress was slowed by the need 1) to remove some of the snow not detached from the ice by the ripper teeth, and 2) to break up the snow slabs from the drum somewhat before the second stage would accept them for ejection. Overall, the volume of snow removed per unit time with this scheme was also well below the blower’s capacity.

The capabilities of the blower were better used by operating the snowblower along the windrows generated by the grader. As noted above, we used the bulldozer to further process (break

up and mix) the snow, and thus maximum efficiency for us was obtained when the snowblower tackled the windrows left by the bulldozer blade.

RUNWAY CONSTRUCTION

Comparing the natural ice survey results to the selected final grade, we could easily determine the amount of grading that will be required and the areas that will require the most effort. Using this information, and all known constraints (workforce size, seasonal operating windows, equipment resources, and support requirements, such as fuel), the management team can refine the construction schedule.

Up until this point in the construction sequence, the runway is fairly protected from solar influences by having some snow cover. However, the following steps will bare much of the ice surface and they should not begin unless ample time and cold temperatures exist to complete the tasks and then recover the surface with a protective cap of snow. Of course this is only critical for sites like Pegasus where temperature and solar effects can cause melting during some periods of the year.



Figure 32. Ice surface following initial snow stripping.

First grading and inspection

Following the initial passes with the bulldozer or V-blade and the snowblower, most of the ice surface of the Pegasus runway was still left with a covering of snow (Fig. 32). To expose the ice and allow close inspection of the surface, we next rough-graded the runway using the Caterpillar 14G grader equipped with a custom-built blade edge (Fig. 33) designed to scrape the ice surface and to shave short wavelength bumps (less than 6 m or 20 ft). This was a somewhat laborious and subjective process because the grader operator needed to choose areas that clearly had high spots and would work them until he was satisfied that the surface was down no more than a few centimeters above its surroundings. The runway generally received its first grading along the entire length in grader-width strips, progressing from one side to the other. When a region of bumps was identified, the grader would operate back and forth to bring them down to a reasonable level before continuing work along its chosen north-south swath.

We discovered that the 14G grader, equipped with the chisel-tooth blade, could remove as much as 20 cm (8 in.) of ice in one pass (Fig. 34). This often resulted in propagating down into the ice the radial cracks that are nearly always associated with large ice blisters (Fig. 35). In some cases, a very large slice of ice was broken loose as the result of catching one of these cracks when grading a thick layer of ice. Usually, the “divot” re-

moved was considerably deeper than desired. Removal of thick layers of ice also encouraged “chatter” or hopping of the grader, which left a choppy and gouged ice surface. Thus, it was necessary to grade the ice in more modest cuts, with 14-cm layers being manageable with no ill consequences.

The geometry of the chisel-teeth and the angle of attack when grading are of utmost importance when attempting to grade ice. Following guidance in Mellor (1977) and somewhat by trial and error, we manufactured the chisel-teeth on our first blade with a height of 7 cm (2.8 in.), an internal angle of 42° , and with side relief angles of about 35° . The basal relief angle was a little more than 30° with the blade aligned perpendicular to the long axis of the grader (Fig. 36). However, when grading ice, the blade was positioned at an angle between 27° and 33° to the direction of travel to allow the spoil to be efficiently removed, so that an actual relief angle of about 26.5° trailed the chisel tooth in the direction of travel. The blade position also caused the ice to be attacked with a pointed edge of the chisel-tooth, rather than head-on as one would normally use a wood chisel or as in the case of the cutting edge on an ice auger. In trials on the first ice blister, we quickly found the proper setup angles for the grader to facilitate smooth and efficient ice grading.

It was probably helpful that initially we operated the grader without any type of traction aids, since it forced us to discover the most effective combination of angles to minimize power and



Figure 33. Custom-built aggressive grader blade used for initial rough grading of runway.



Figure 34. Aggressive grader blade removing up to 20 cm (8 in.) of glacial ice in one pass.

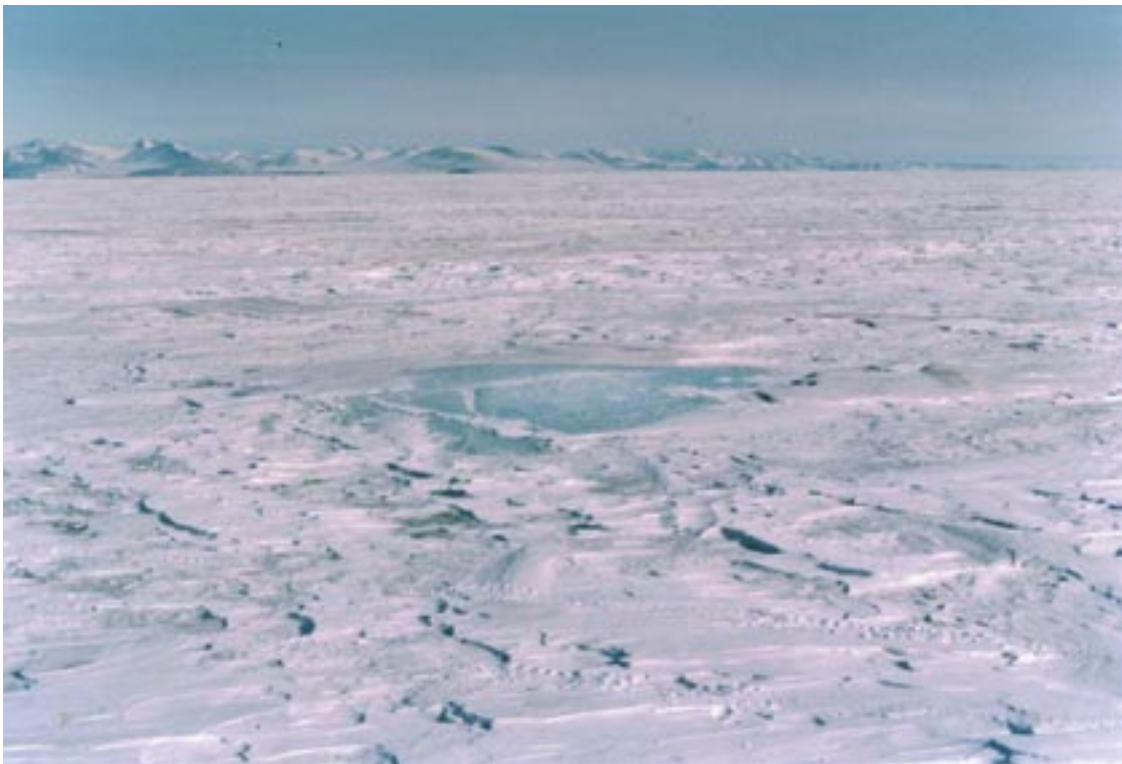

Figure 35. Small ice blister formed from freezeup of melt pool showing radial cracks.

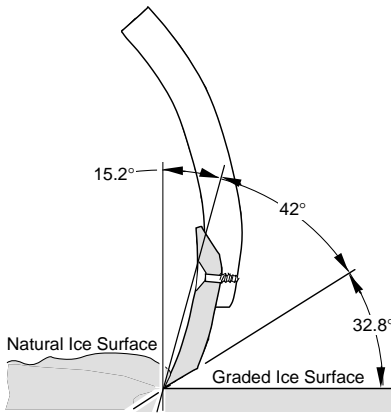

Figure 36. Attitude of grader blade and chisel-teeth during grading.



Figure 37. Aggressive tire chains as used in logging industry installed on motor grader to reduce slip during ice grading.

traction requirements. Through this process, and the results of later testing with refined chisel-tooth design patterns and the addition of aggressive tire chains (Fig. 37), we calculated that an efficient ice-cutting blade, held in the proper position, will require 122 kW per lineal meter of actual cutting edge (50 hp per lineal ft) to propel.

During rough grading, we easily maintained 5 km/hr (3 mph) with the grader at a gross mass of 23,500 kg (52,000 lb).

We also discovered that it was very helpful to sharpen the edges of the grader blade daily with a hand-held disk grinder. The chisel-tooth edges dulled surprisingly fast when grading the ice, principally because of the large amount of mineral matter trapped in the ice (Fig. 38). Although laborious, daily facing of the chisel-teeth with a grinder increased tremendously the efficiency of the grader.

The snowblower was used to remove the ice spoil windrowed by the grader. Since most of the spoil material consisted of fist-sized chunks of ice, we were cautious about the rate of advance with the snowblower. The Rolba blower, however, proved to be robust enough to allow ice ingestion at a good rate. Ingestion of the ice created significant vibration throughout the snowblower and prime mover, but only a few parts were broken, even after 1000 hours of operation and the processing of 1 million tons (907,000 tonnes) of ice. Once the snowblower removed the spoil from this grading, a mostly exposed surface of ice remained (Fig. 39).

Other devices could be used to remove the spoil (e.g., bulldozers, bucket loaders, graders), but the blower has the advantage of moving the debris a large distance and spreading it so that no ridges remain. The blower is susceptible to winds, and at times we were hampered in our progress by not being able to cast material to one side of the runway because of stiff winds. In choosing a snowblower for such a task, ruggedness must be a prime requirement. Blowers designed for opening roads in mountainous regions and that are equipped to ingest rocks and trees (such as is often present in avalanche paths) are suitable. The speed and capacity of the snowblower should be carefully matched with the grader. There are many issues that can benefit from this matching. By having the ability to maintain pace with the grader when working, windrows (which can trap additional drift snow) are never present for long periods of time. By not setting long, the snow in the windrows is not allowed to setup and become hard after the working process of the blade, thus reducing the power needed to remove pick up and throw the snow. Additionally, operators can remain in visual contact with each other in case of a breakdown, an



Figure 38. Mineral matter trapped in the ice.



Figure 39. Ice surface following initial grading.

emergency, or rapid change in weather (temperature or wind direction), or if there is a need to discuss progress. Also, matched performance allows the operators to start and finish work cycles on the same timetable so that they can share breaks, meals, and transportation. It is probably

best to first select the grader(s) needed to efficiently produce the glacial ice runway in the time period desired and then to determine the snowblower(s) that will be compatible. We estimate that 37 kW (50 hp) of snowblower power is needed to match each foot of grader blade.



Figure 40. NCEL ice grinder. (Photo by J. Barthelemy, NCEL.)

If the site chosen requires that very little grading, other devices may be used to remove spoil. In addition to those named above, a rotary broom, a towed grader or angle plane, a drag box, or a scraper could be utilized at much less expense and complication.

We see few alternatives to using a grader (with a blade similar to the ones we built) for smoothing a bumpy natural ice surface. Although a similar cutting edge can be placed on the lower lip of a bulldozer, the crawler tractor will be difficult to operate so that a reasonably level surface results. Another option is an ice grinder, such as was designed for a similar purpose by the Naval Civil

Engineering Laboratory (NCEL) (Barthelemy and Thomas 1993). The “NCEL grader” combines the functions of ice-cutting and debris removal (Fig. 40), but was designed for use on sea ice, which is often considerably weaker than glacial ice. We suspect that this grinder would work well for ice surfaces that required minimal smoothing/leveling. If significant numbers of large bumps exist, or much of the terrain requires a grade change, the capacity and speed of the NCEL grader are probably insufficient. In addition, a laser-guidance system would probably be required to achieve the degree of smoothness needed for a runway.

Following initial grading and debris removal, the runway should be carefully inspected and sampled to determine ice integrity, including the presence of cracks, variations in ice appearance or surface strength, potholes or other melt features, and to affirm the topography revealed from the initial survey data. Cores should be taken, especially in low spots, to determine how much ice might need to be graded to remove all porous or weak ice. This weak ice, which we called trash ice, is typically found in the shallow basins on the runway surface and often has large bubbles, incorporated lenses of snow, high concentrations of mineral particles, and occasionally is held together only with thin segments of ice plates (Fig. 41). The trash ice we discovered



Figure 41. Poorly consolidated ice including snow pockets.

seemed to be indicative of recent seasonal melt/refreeze activity near the ice surface. The trash ice had little bearing strength and in areas would break under the pressure of a light utility truck tires.

The goal of this last reconnaissance of the ice is to make decisions about the final grade for the runway. In most cases, a single grade for the entire airstrip is neither practical nor necessary. A series of tabular segments, joined at a common elevation (or nearly so), will be adequate for nearly any aircraft that would use a glacial ice runway. For the purpose of efficiency during grading, it probably does not make sense to design for tabular segments any shorter than about 300 m (measured along the length of the runway). Each segment should be level across the runway width (perpendicular to aircraft travel direction) but may be sloped along the length.

Filling of low areas

In some situations, a single, or small number of, low areas may suggest a significant amount of grading to arrive at a plane surface. Filling such low areas is possible, although it is not as straightforward as with earthwork. Filling low areas may be an attractive and economical alternative to having to grade huge areas just to accommodate a low-lying segment of ice.

At Pegasus, we filled an area that extended between the 5000- and 7000-ft markers along the runway and spanned the full width of the runway. (Distance along runways is most commonly given in multiples of 1000 ft [305 m]; thus we will use English units when referring to location along the length of the runway.) We approached this task by massive flooding of the area using a portable snow melter (Fig. 42); the snow melter was diesel-fired and was fed by a bucket loader. Once

operating efficiently, the melter was capable of producing water at close to 1900 L/hr (500 gal./hr). We discovered quickly that this method of fill was wrong for two reasons. The fill operation wasn't initiated until mid-November, which meant that air temperatures and solar intensity were moderately high and rising significantly with time. Thus, the water acted as a heat sink and was not only reluctant to freeze, but actually caused melting in much of the surrounding ice and snow. Parts of the runway turned into a lake and remained so until late in January. When the water finally did start to freeze late in the season, the top of the water froze quickly, producing an insulating cap that drastically slowed the cooling and freezing of the bulk of the water. We discovered later (see Chapter 5) that this allowed large, oriented ice crystals to form, yielding very brittle, weak ice.

Large fill operations should be conducted only at low temperatures, in the range of -10°C or less. Low areas should be prepared before water application by essentially filling the entire basin with snow and broken-up ice chunks. Construction debris is ideal for this purpose, and the grading following initial strip-off should provide ample material of an ideal mix of snow and ice. This fill material should be compacted as much as possible by repeated passes with a vehicle. A bulldozer tractor with wide tracks is ideal since it will have significant weight, and the passage of track-guide rollers (boggies) acts to vibrate the fill, assisting in compaction.

Once the low area is filled with compacted snow and ice, it should be flooded slowly with fresh water from the edges. The goal is to slowly flood the interstices of the compacted snow and ice, allowing air to escape and ensuring that no large pockets of unsaturated fill are trapped and



Figure 42. Portable snow melter.

that the water freezes quickly. Flooding the fill in separate lifts may be necessary to allow the lowest levels to freeze before more water is placed on top. In essence, the fill procedure should simulate an ice bath that is allowed to freeze rapidly, thus creating a mass of small-grained, randomly oriented ice crystals. This will produce a very strong filler for the low area.

The surface of the frozen fill will be very rough. We discovered that it was best to fill the basin with snow and ice debris to an elevation slightly higher than the final anticipated grade. Thus, the surface can be finish-graded along with the natural ice surface to provide a uniform texture for traffic.

Few alternatives to a snow melter exist for generating fill water at a remote site. If only a small amount of water is needed and the site is near an established camp, water may be transported to the site in containers via helicopter or oversnow vehicle. In some cases, natural meltwater on the glacier at a nearby location may be utilized. This water may be transported or pumped to the site via a hose. If a very large amount of water is needed and a large capacity snow melter cannot be used, establishing an in-situ water reservoir in the snow (commonly called a Rodriguez well) it may be possible nearby in the glacier to supply freshwater needs (Lunardini and Rand 1995). If a camp will eventually be placed near the runway site, such a well may be useful to supply its water needs in the future.

We caution against the use of seawater for use in patching or filling. During the process of freezing, seawater rejects its salt content, resulting in pockets of brine. This will only freeze at low temperatures and results in ice with significantly inhomogeneous strength properties. Thus, the

thermal and mechanical properties of the fill area will be very different than for the remainder of the glacial ice runway. This will make certification of the runway more difficult, and could easily cause the runway to be unusable because of the failure of a small portion of the surface.

Preparations for final grading

During the final runway survey, benchmarks should be set along at least one edge of the runway. These markers are best situated about 6 m (20 ft) from the anticipated edge of the runway to allow equipment to operate along the flanks of the runway without the danger of damaging the markers. It may be necessary to keep the benchmarks buried in snow to protect them from solar heating. We buried all but a few centimeters of 1-m-long square timbers for use as benchmarks. The markers need not be listed with actual elevations, as long as the height of their tops are known relative to each other. For runway elevations, we used the base of the tower supporting the Pegasus North AWS, situated just off the north end of the runway. This master datum was arbitrarily assigned an elevation of 30 m (100 ft) and all other elevations were listed with reference to this benchmark (actual elevation is about 6 m or 20 ft). We also placed flags along both sides of the runway, set 7 m (23 ft) out from the edge and located every 500 ft along its length. As is typical for runways, each 1000-ft multiple was numbered.

After the final ice reconnaissance, core inspection for weak ice, filling of any large depressions, and setting of benchmarks, the final grade for the runway will be decided. This decision will be based on minimizing the amount of grading necessary by matching the natural topography as much

as possible (which also reduces the amount of debris to be removed) in order to produce a surface that meets the roughness standards for the most stringent smoothness requirements associated with the aircraft that will use the facility.

The final grade for the Pegasus runway was set in three segments (Fig. 43). Each of these segments was designed to exactly match elevation at their intersection points, although this would not have been necessary (steps of as much as a few centimeters would not have caused any distress to the aircraft for which we designed). Two of our segments

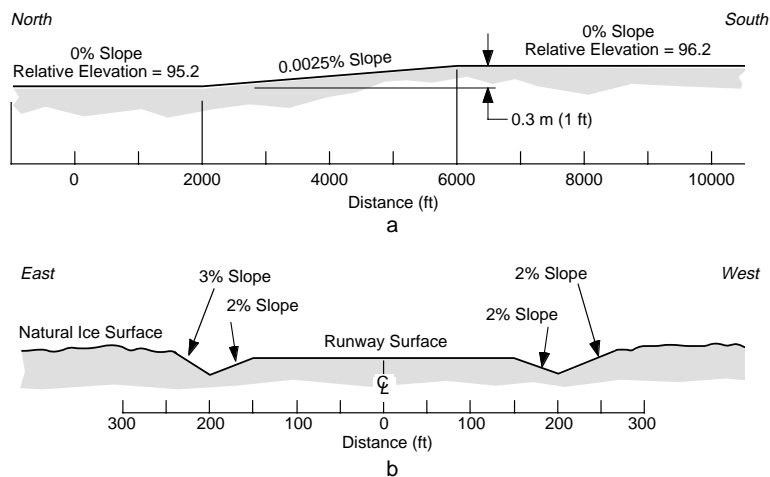

Figure 43. Final grade plan for the Pegasus runway.



Figure 44. Motor grader under laser control during final grading of ice. Transmitter is mounted on robust, portable tower.

were actually level (-750 to 1000 ft and 6000 to 10,500 ft) at relative elevations of 95.2 ft and 96.2 ft relative to the arbitrarily assigned 100-ft master datum. The grade on the sloping segment (1000 to 6000 ft) was only 0.020%, essentially undetectable.

Final ice grading

Far and away the most efficient means of producing a final grade is to use a laser-guidance system (Fig. 44). This is not, however, a substitute for good operators. Coupling an experienced operator with a laser system has significant advantages when producing an ice runway surface:

- Most laser systems will operate in a 300-m- (1000-ft-) diam. circle and thus allow a single surveyed position (the position of the laser transmitter) for each 1000 ft of distance along the runway.
- Long-wavelength bumps (i.e., greater than the wheelbase of the grader) will be removed although they are most likely undetectable by the grader operator, no matter how good he/she is.
- Even on sunny days, there is very little visible contrast when working on ice, and it is difficult for an operator to “work by eye” and arrive at a level surface.



Figure 45. Custom built chisel-tooth grader blade used during finish grading of runway.

- There may be many days when weather conditions reduce surface visibility to near zero due to diffuse light or blowing snow.

We found that the laser system was able to function and produce accurate grade even when the grader operator had great difficulty seeing well enough to drive in a straight line. However, we found that the standard laser system transmitter tower was not robust enough and began vibrating under moderate wind conditions. This caused the emitted laser plane to shift rapidly and with such amplitude as to cause the grader blade to go into convulsions. Thus, we constructed a sturdy tower, mounted on skis for efficient repositioning, on which to place the transmitter (Fig. 44).

For finish grading, we used a different chisel-tooth design for the blade (Fig. 45) than was used for initial grading. This blade appeared more aggressive than the one used for the first passes and was designed with an alternating tall- and short-tooth pattern to assist in cleaning the surface of all debris. The geometry of the cutting teeth was similar to the rough grade blade with an included angle of 42° and side relief angles of 41° (Fig. 46). However, the cutting teeth were considerably longer, at 9.6 cm (3.8 in.). The cleaning teeth had an internal angle of 60° , a height of 5.7 cm (2.2 in.), and no side relief cut-out. The lower edge of the cutting teeth was flared to a width of 5.7 cm (2.2 in.) and was 4 cm (1.6 in.) closer to the ice than the cleaning teeth. For most of the runway, only one pass was required to arrive at the de-

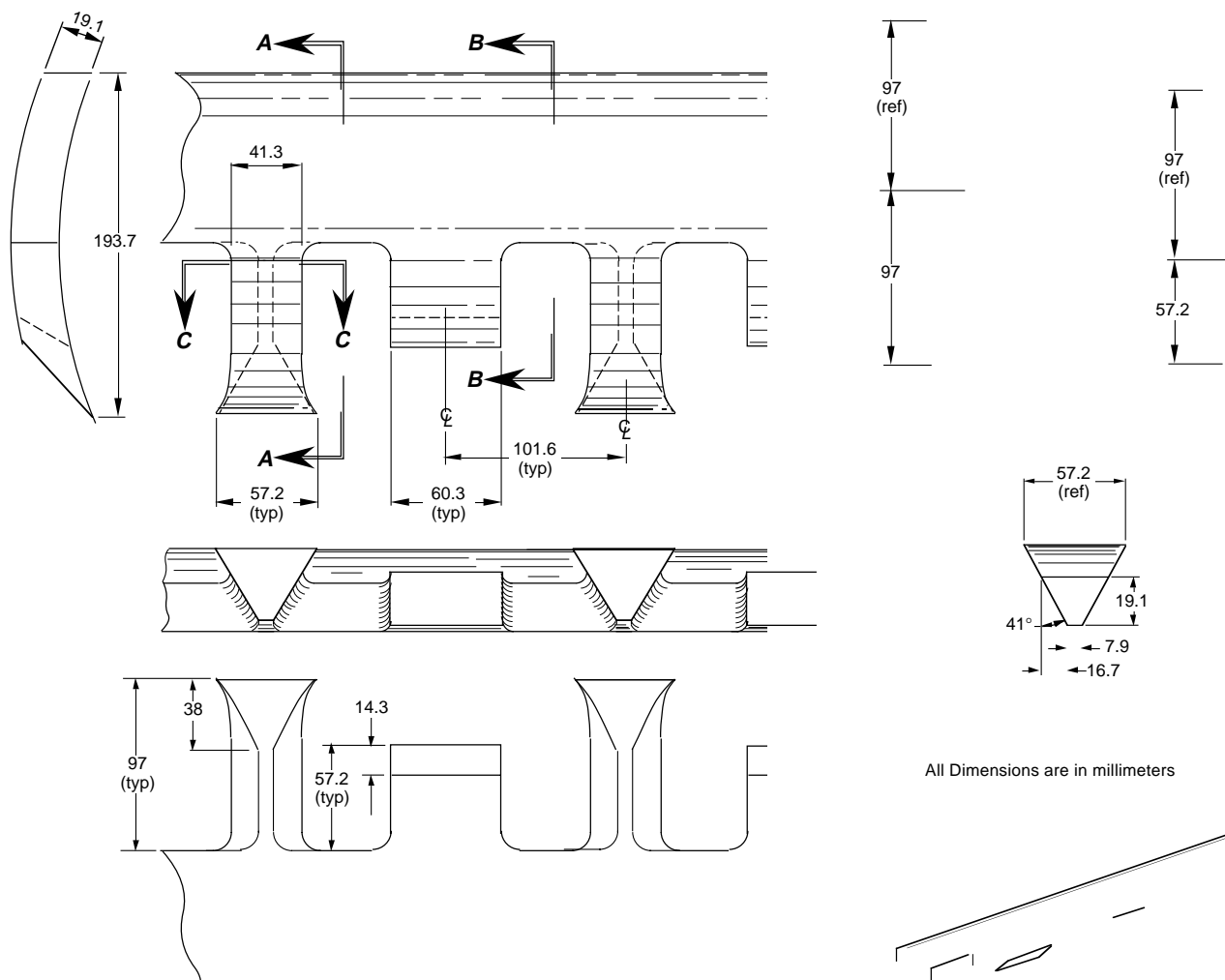

Figure 46. Geometry of individual chisel teeth.



Figure 47. Finish-graded ice surface seen in foreground with rough graded segment of runway in background.

sired final grade. The grader was removing less than 4 cm of ice, and a speed of 3–4 km/hr (2–2.5 mph) could be maintained.

Each 1000-ft segment of the runway was finish graded to yield either a level or sloped surface (Fig. 47). (All surfaces were level across the width of the runway.) Initially, we possessed only a simple planar laser transmitter. This required that we “recalibrate” the transmitter to be deliberately out of plane by the amount that we desired for the segment being worked. Most planar transmitters have a very limited range of slopes for which this will work, but in our case, it was easily accomplished. Later we obtained a dual-slope transmitter, which is specifically designed for planar or sloped surfaces. Grading sloping surfaces is much easier and more accurate with this system. We recommend a dual-slope transmitter for any operation, since it is much more versatile and easy to use (e.g., transitions between segments are much smoother). The runway was graded from the centerline outward, to facilitate leaving a clean surface (both the grader and the snowblower were casting material toward the edges of the runway).

The finish-graded runway surface will almost always be somewhat depressed relative to the surrounding natural ice surface. If meltwater is flowing on the ice surface nearby (perhaps under the snow), it will seek the runway as a convenient

ponding location, even if the runway is protected from melt during the hottest part of the season. We graded “negative” slopes (2%) away from the runway along all of its borders for a distance of 15 m (50 ft). From their lowest point, we then graded slopes extending back up to the natural ice surface (Fig. 43). Thus, we created protective “ditches” along the flanks of the runway. These flank areas were covered with a of snow (about 15 cm, or 6 in.) following construction to protect them from deterioration and to assist in impeding water flow toward the runway.

SNOW MANAGEMENT DURING CONSTRUCTION

During the process of preparing the site, every effort should be made to leave a smooth surface, at least at the end of every workday. We discovered that even a light wind can carry considerable amounts of snow just above the ground surface, and small ruts or windrows will trap this snow (Fig. 48). The result is a net accumulation of snow when often the intent is to remove material. Our practice was to follow the grader, V-plow, or ripper very closely with the snowblower so that windrows and rough snow surfaces were not present for long periods of time. Likewise, the windrow size was based on what the snowblower



Figure 48. Small windrows trapping blowing snow.

could completely remove in one pass. Thus, the swath left by the two vehicles during the stripping operations was smooth and did not have sharp or dramatic edges.

On days when a strong wind is blowing, it may be best to avoid any work on the runway that might trap snow. On such days at Pegasus, we often continuously dragged the runway surface to break up forming drift pods to prohibit them from becoming large and trapping even more snow. Our goal was to keep moving snow moving during the time that it was in the vicinity of the runway.

There may be occasions when covering an area that is devoid of snow may also be desirable. It is usually a simple matter to use the snowblower to cover small areas or even to use a bulldozer or grader to move snow to cover bare ice. However, when large areas are in question, we found that using natural processes is very efficient whenever possible. Periodically we deliberately generated small windrows with the grader, perpendicular to the prevailing wind direction, to trap snow being carried along the surface by the wind. We found that windrows of about 10-cm (4-in.) height spaced 5-m (16-ft) apart would, within a few hours, trap a volume of snow roughly equal to the volume of the initial windrow when snow was being carried in the wind stream, even at low speeds. By dragging or planing the surface after

snow accumulation slows (i.e., drift snow extends up to the top of the windrow), one can set new windrows and this process can be repeated to arrive at the desired snow cover within a relatively short period of time when a wind is present and is carrying snow.

At most sites, snow management will always be the highest priority task. The development and application of a comprehensive snow management plan is critical to the success of such a facility. It may be necessary at times to put aside all construction activities and to employ the entire crew with dressing snow surfaces to avoid snow accumulation or to collect snow for protection. While this may be a frustrating disruption of the construction schedule, we discovered that one can almost never overpower the will of natural forces in polar regions, and that it is always most efficient in the long run to “go with the flow” of how the environment is behaving at any point in time.

Because the Pegasus runway project began as an experiment, only minimal consideration was given to the construction spoil. With limited personnel and equipment dedicated to the project, the possibility of properly addressing construction waste was a moot point. Thus, large berms of snow and ice chunks were generated along both sides of the runway. Because of prevailing winds, the berm on the west side is larger than that on

the east. We did manage to maintain the shape of the east berm to minimize drift snow accumulation; eventually, near the end of the project, we did some shaping of the west berm.

The long-term effect of these construction berms is not known. Originally, we feared that they would attract large amounts of drift snow and quickly inundate the runway. However, we have been monitoring the berm profile at several locations across the runway and have noted little net gain in the volume of snow present in the vicinity of the site (see survey sections in App. C; Lang and Blaisdell, in press).

Initially, the berms at the Pegasus runway were a mixture of fine-grained medium-density snow and ice chunks. In the three years since the berms began to build, they have become firm. Attempts

to remove the berms now would require considerable effort and expense, no doubt involving large construction equipment. Continued monitoring of the cross-sectional profile (App. C) will provide an indication if the site is unstable. Minimizing berm height and side slopes will assist in reducing snow buildup, but caution is required when shaping the berms to assure that small-scale surface features associated with equipment operations do not trap and add significant amounts of snow. Should it prove that the berms generated during construction eventually cause the runway to be swallowed in drift snow, the runway can be rebuilt more efficiently than initially and with management of construction wastes incorporated in the construction plan from the outset.

CHAPTER 4. RUNWAY CERTIFICATION

While a great deal of effort and time will have been spent to select the location and to construct a runway, this by no means qualifies the site as an airport. In preparation for aircraft operations from the glacial ice all parties (e.g., construction team, field engineer, project sponsor, site manager, flight company, and pilots) must be confident of the ability of the runway and the site to safely support flight operations. Many of the preliminary steps in the process outlined here will have indicated that the site characteristics are suitable for aircraft operations. However, final certification of the runway by some appropriate authority is only prudent, because lives and expensive equipment are at risk.

SMALL-SCALE MECHANICAL TESTS

A series of cores should be taken from random locations on the runway. Any locations where fill was added, and sites where particularly large blisters were graded, should also be cored. The core holes should be inspected to ensure integrity of the subsurface ice. Since grading of the surface ice will have exposed lower horizons of ice, small-scale compression tests should be completed on the top of these cores and from a segment of the core about 0.5 m (1.5 ft) from the top. Simple unconfined compression tests are adequate for ensuring that the ice will support a stress suitable for the aircraft to use the facility. More sophisticated compression tests may be performed and will yield more information on the ice's mechanical behavior (e.g., stress-strain response, elastic modulus, Poisson's ratio), but the most important quantity to obtain is the stress at the point of brittle failure.

These mechanical tests should be performed at ice temperatures within a few degrees of the temperature at the time of anticipated runway use. If the runway will be required to support aircraft over a range of ice temperatures that vary more than about 10°C (especially if some of these temperatures are above -5°C), mechanical tests should be done at two or more temperatures representing the range. During core testing, the loading rate should be no less than 44 kN/s (10,000 lb/s). We recommend that the ice cores be able to support a compressive stress of at least 2.0 times the maximum contact pressure (essentially the maximum tire pressure) of the design aircraft. The

30% overload factor, although seemingly somewhat small, is really quite adequate, since the in-situ ice is in a confined state.

If weak ice or gaps and crushed horizons are discovered, further coring should take place to determine the extent of the problem area. If the area is relatively small, the process of full-scale testing and patching can be used to bring them up to a suitable strength. If the extent of the problem area is too large to lend itself to repair, several options exist. Repositioning the runway slightly to one side may be to allow the weak area to be abandoned. Of course, if the weak area is centrally located, this could require a lot of work and is probably not desirable. Another possibility is the use of a compacted snow cover to assist in load distribution. This may be an attractive option only for sites where significant quantities of snow are available and at sites that would require a protective cover anyway during a portion of the season to avoid solar-induced degradation.

As a last resort, the bearing strength of the ice from these tests can be used to set the limit for aircraft contact pressure. This may mean that a different type of aircraft will need to be used at the site, or possibly that a reduced inflation pressure will need to be maintained for operations at the glacial ice runway. The latter may be feasible, since heat buildup of tires will most likely not be a problem when operating in polar regions, but reduced tire pressure may require a reduced payload.

FULL-SCALE LOAD SIMULATION

In preparation for the first flight at a glacial ice runway, full-scale testing will stress a far greater percentage of the runway than most mechanical test methods. In addition to being good engineering, the full-scale test may have important psychological benefit to pilots, flight managers, and others. This will relieve the construction team and field engineer from having to rely heavily on statistical means for certifying the integrity of the runway. Full-scale testing is not cheap, but this cost should be placed in perspective with the value of aircraft and the persons who will use the runway.

Ideally, full-scale tests (proof rolling) should simulate the worst possible case. For aircraft operating on glacial ice, this translates to maximum



Figure 49. Cart for proof rolling the Pegasus runway shown configured for C-130 landing gear; ballast is steel plate.

allowable main landing gear loads and contact pressures moving at very slow speeds or at rest. Contrary to what may be thought, landing impact loads rarely exceed maximum static loading (O'Massey 1978). Upon impact during landing, the tire load is equivalent to the vertical kinetic energy only (related to aircraft sink speed), since the aircraft still has flying speed and thus the wings carry a lift force equivalent to the mass of the aircraft. Maximum allowable aircraft loads can be found in the aircraft maintenance manuals or from Jane's Defense Data publication, *All the World's Aircraft*. It should be remembered that 90–95% of the aircraft weight is carried by the main landing gear.

Proof rolling should cover as much of the runway as is practical. In most cases, it should be possible to stress essential every square meter of the runway by maintaining wheel tracks at a close spacing (1 m or 3 ft). We recommend that a minimum factor of safety (FS) of 1.25 (125%) be applied to the maximum allowable aircraft loads and pressures. This is the same FS that is used for the McMurdo sea ice runway (Barthelemy 1992) and is estimated to be incorporated in the FAA design manuals for the thickness of conventional airport pavements*. Proof rolling speed should not exceed 5 km/hr (3 mph).

We designed and built a cart (Fig. 49) for proof rolling the Pegasus runway. The cart is capable of

being fitted with either C-141 or C-130 main landing gear wheels and tires. Tire configuration on the proof cart is nearly identical to an actual aircraft. The cart has a flat deck for placement of ballast to a mass greater than the maximum allowable load on the main landing gear of the aircraft (e.g., 97,699 kg or 215,100 lb for a C-141; 67,600 kg or 148,800 lb for a C-130). Because of the very large loads the cart carries, it was designed to be flexible (i.e., most structural members were bolted together) to reduce the possibility of component failure when the cart travels over

uneven terrain or breaks through the ice at one tire station. During its initial use, the proof cart was ballasted with large steel sheets that were on-site in McMurdo for future construction of fuel tanks (Fig. 49 and 50a). The steel provided a concentrated source of mass, thus holding the center of mass to a modest level. Because of their flexibility, the large, thin steel sheets were difficult and dangerous to handle during loading and unloading. Later, 1-m³ concrete blocks were used for ballast on the proof cart. These blocks were manufactured in the U.S. and contained forklift pockets at the bottom and a recessed lifting ring on the top to aid in handling. The blocks proved easier to place and secure on the cart, and it was easier than the steel sheets to calculate and adjust the total ballast mass. However, the concrete blocks resulted in a much higher center of mass and there was some concern for stability during operation (Fig. 50b). Extensions were added to the fore and aft “outriggers” to address this concern, but, the cart proved to be well balanced and the extensions may not have been needed.

The proof cart is designed to “catch itself” on long steel runners if an ice failure occurs under a wheel. When the cart is not in use, we parked it with wooden blocks under these runners to support the load, thereby reducing stress on the axles and wheels and limiting pressure sinkage into the ice. The proof cart was surprisingly easy to tow. We found the proof cart most efficient to pull with the 14G grader, since this provided a comfortable ride for the operator and allowed a speed of 4–5 km/hr (2–3 mph) to be maintained.

*J. Scott, FAA Northwest Regional Pavements Specialist, personal communication, 1995.



a. Ballasted with steel plate.



b. Ballasted with concrete blocks.

Figure 50. Proof cart configured for C-141 landing gear.

In addition, the grader is easy to operate in a straight line. When the grader was not available, we used an LGP D8 bulldozer effectively. It was difficult to maintain a straight line when towing with the bulldozer, and the speed and comfort were compromised when using this tractor instead of the grader. The proof cart was also much easier to turn at the ends of the runway when towed with the grader compared to the D8.

At the Pegasus runway, our ultimate goal was to certify the runway for C-141 use. There were questions about whether the C-141 or the C-130 would provide the more severe test of runway strength since the contact pressure was higher for the C-141, but the individual tire load was higher for the C-130. Our initial configuration for the proof cart was for the C-141, with eight tires supporting a total mass of 121,900 kg (268,500 lb).

The first pass of the proof cart (on 8 November 1992) was down the centerline of the runway. During the first pass, six weak spots were discovered. In each case, a single tire, or one pair of the four pairs of proof cart tires rutted the ice (Fig. 51). A total of 12 round-trips were made with the proof cart resulting in 48 individual tire

tracks down the entire length of the runway. This yielded an average space between tire tracks of 1.4 m (4.5 ft) (Fig. 52). Approximately 40 ice failures occurred. The failures were noncatastrophic and were often difficult to detect when they occurred. At no time did the proof cart sink more than 13 cm (5 in.) and the grader had no problem continuing to tow the proof cart. For this reason, we feel confident recommending what might seem to be a low factor of safety (FS) of 1.25. We caution against using a FS any greater than about 1.5. No good is served by grossly overloading the ice, perhaps creating numerous failed areas; this only serves to erode confidence in the runway's ability to support aircraft. However, if it is discovered that ice failures are catastrophic, creating deep potholes and potentially damaging aircraft or their handling characteristics, then a greater FS may be warranted.

Close examination of the failure points revealed that they were all located in meltwater ice (ice that formed from freezing of water from the prior season's melt pools or the snow melter water used to fill the large depressions in the natural ice surface). Blocky pieces of ice were generally present



Figure 51. Site of failed runway ice caused by proof cart.

in the center of the failed zone. Slabs could sometimes be seen displaced upwards a few centimeters along the edges of the failure area. When removing the ice blocks from these areas, we often observed a crushed and crumbled zone along the lower sides of the scooped-out bowl. In some cases, a shale-like structure could be seen in the bottom and sides of the bowl extending into the sound ice (Fig. 53). The area of individual failure zones varied from about 0.1–1.1 m² (1–10 ft²) and they were 7.5–45 cm (3–18 in.) deep.

A sketch map of the failed zones (Fig. 54) shows a concentration in the 5000- to 7000-ft region. This is the area that had a natural depression and was manually filled with water in November of 1991. This area did not completely freeze until after February (1992). The other failures also tended to be concentrated into areas where known subsurface melt pools had formed the prior year. No failures were experienced in the natural glacial ice.

Cores were drilled in the immediate vicinity of a number of failure zones. The cores confirmed that the ice at these locations was meltwater ice. This ice was very brittle and, occasionally, contained many visible but closed cracks. It is difficult to tell exactly what caused the cracks to form, but likely possibilities include 1) release, by coring, of trapped stresses in the meltwater ice, 2) cracks induced by aggressive grading of the ice surface, and 3) cracks formed during



Figure 52. Closely spaced proof cart tire tracks during full-scale load certification of runway.



Figure 53. Failure planes in ice extending into sides of main cavity of failed area.

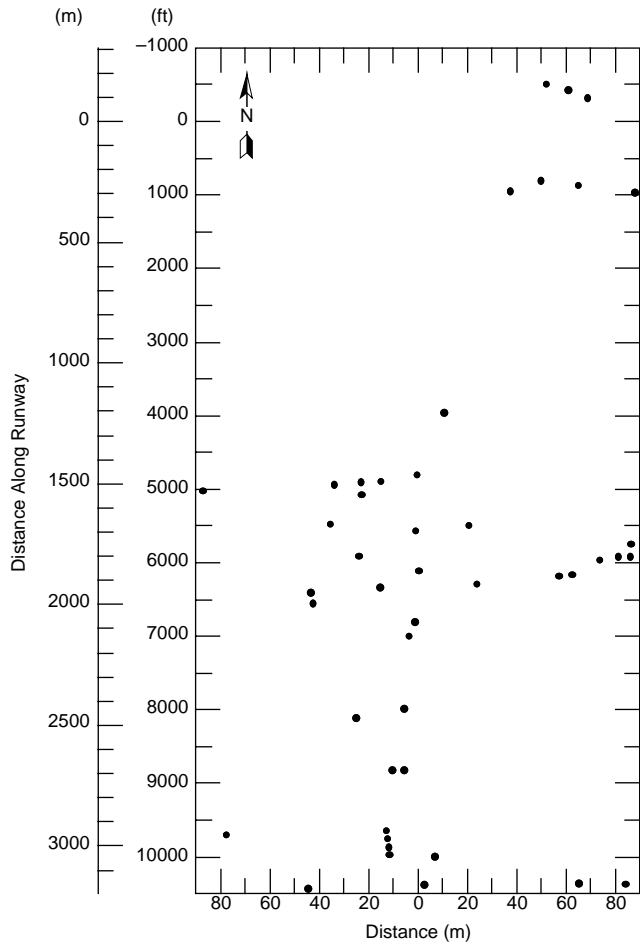

Figure 54. Sketch map of locations on runway where proof cart failed ice.

heaving and blister formation (Fig. 35) when freezeup occurred in the prior austral autumn. Certainly some prefracturing of the ice occurred during construction of the runway. Aggressive grading was used to level the ice surface to bring it into tolerance for aircraft operations. The grading introduced cracks in the near-surface ice, particularly in areas where former blisters (domed ice with radial surface cracks) were located. Encountering a blister, the grader blade often caught the radial cracks and caused them to propagate. On its own, the grading process probably introduced new near-surface cracks as well.

We conclude that the following factors contributed to the brittle failures witnessed in the Pegasus runway ice:

- Large grain size ice in areas where the natural glacial ice had experienced melting and refreezing.

- Application of a high rate of loading by moving vehicles which predicated operating within the brittle failure regime.
- Pre-existing internal damage to the ice (from blister development during refreezing and from runway construction activities).
- The presence of many included impurities in the ice structure.

Thin sections of the ice cores were taken from the north threshold (0-ft), and at the 6000-ft and 10,000-ft areas of the runway. The cores at 6000-ft and 5000-ft locations were macroscopically similar in structure. A complete profile of the core from the 6000-ft location is shown in Figure 55. Clearly this ice was formed by flooding with snow-melt water during runway construction. The top of the core is characterized by 2- to 3-mm (0.08- to 0.12-in.) diameter, randomly oriented ice grains included in 8- to 35-mm- (0.3- to 1.4-in.-) equiaxed

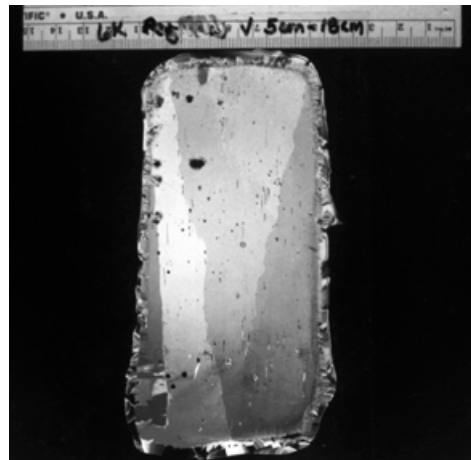
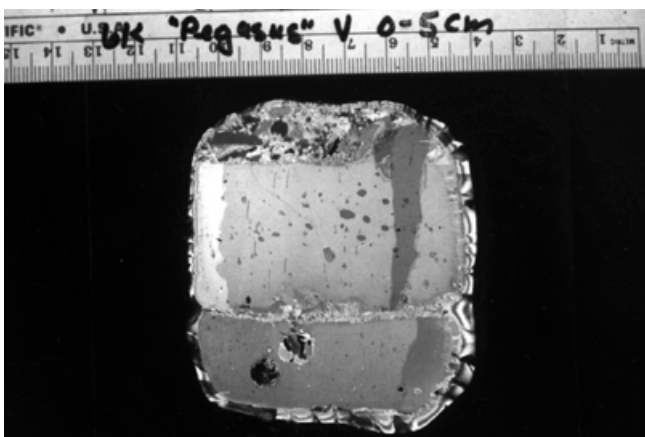
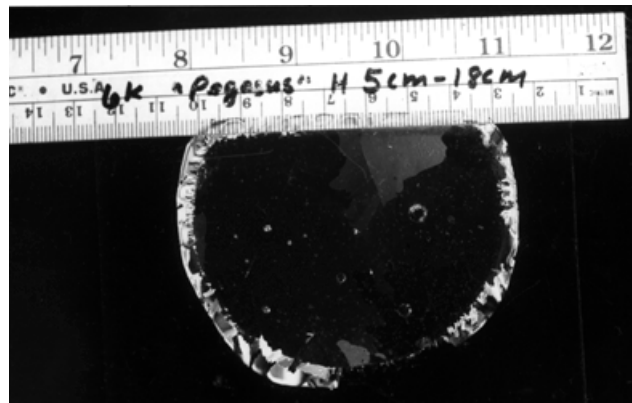

a. 0- to 5-cm horizon.

b. 5- to 18-cm horizon.

Figure 55. Horizontal and vertical thin sections of core sample removed from the Pegasus runway surface at the 6000-ft zone.

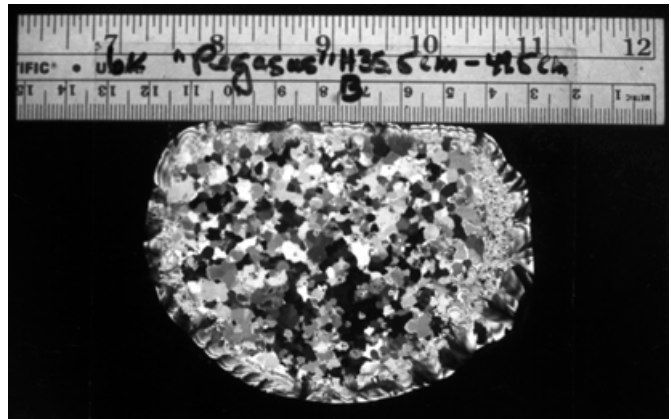
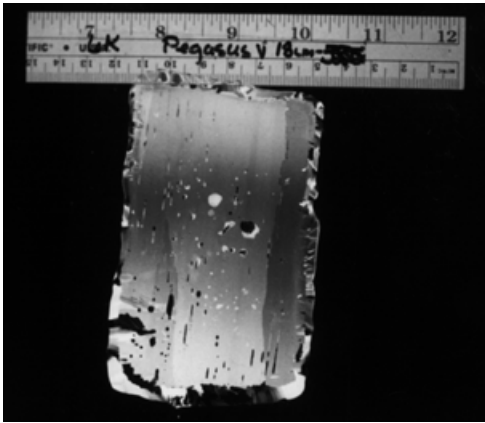
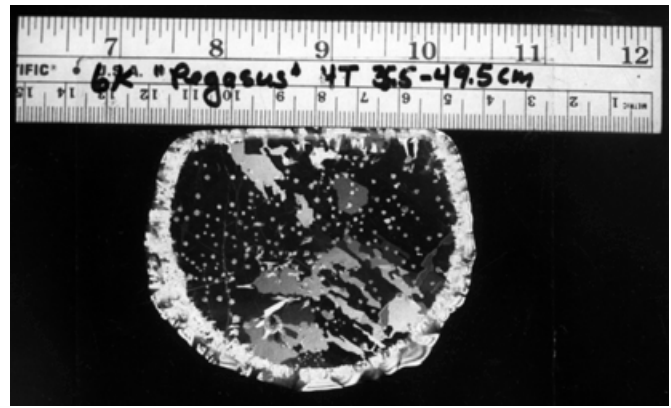
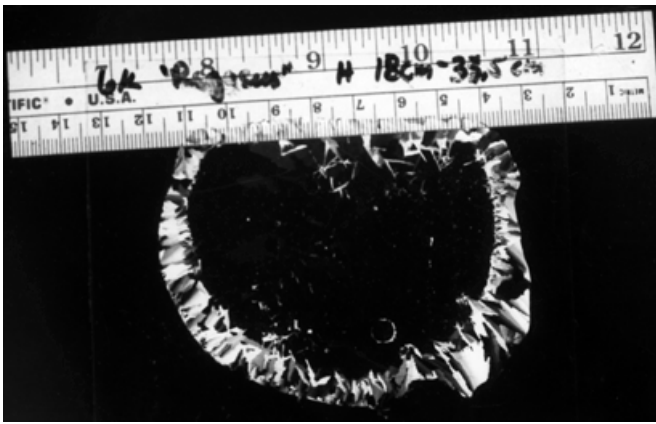

c. 18- to 35.5-cm horizon.

ice grains with the c-axes normal and nearly normal to the natural ice surface. The horizontal section shows the grain diameter and degree of extinction and the vertical section shows the columnar nature of the ice down to approximately 40 cm (16 in.). At the 5-cm (2-in.) depth, a horizontal discontinuity is apparent with crystals less than 0.5-mm diameter in this zone. As the vertical grain boundaries are discontinuous at this gap, probably the top 3 cm (1 in.) experienced melting and recrystallization a second time.

The number of inclusions decreases with depth. Between 18- and 35-cm (7- and 14-in.) depth, internal damage is apparent with 2- to 7-mm (0.8- to 3-in.) radial cracks. Grain boundaries are not well defined and the grains are more elliptical with jagged boundaries in the horizontal plane. At the 40-cm (16-in.) depth, a distinct boundary occurs, delineating the meltwater ice to glacial ice transition. From 40 to 68.5 cm (16 to 27 in.) the ice is characterized by 0.5- to 5-mm (0.02- to 0.2-in.) diameter, randomly oriented grains with some intrusion of melt at the boundary to a depth of

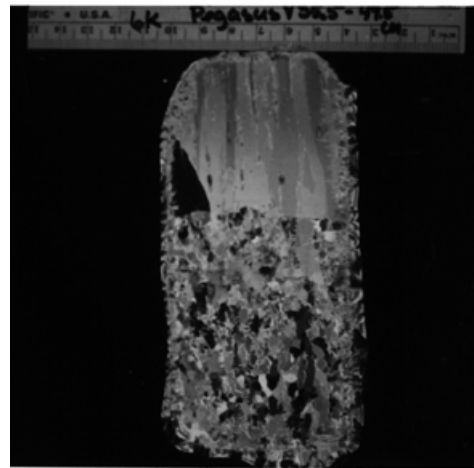

d. 35.5- to 49.5-cm horizon.

Figure 55 (cont'd).

approximately 45 cm (18 in.). Bubbles increase in size with depth until the bottom of the core at 68.5 cm (27 in.).

At 10,000 ft along the runway (south end), the ice at the upper horizon (0-11.5 cm or 0-4.5 in.) is randomly oriented and grain sizes range from

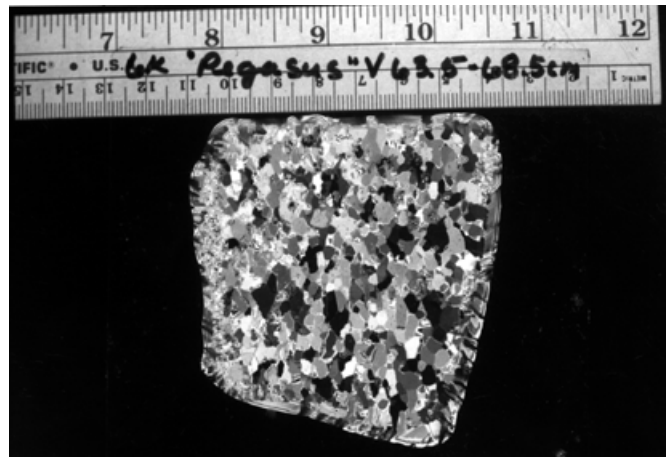
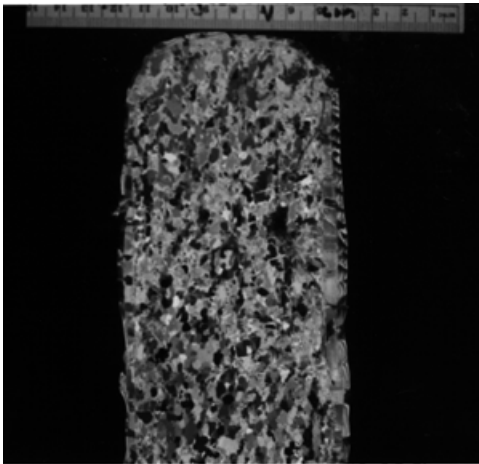
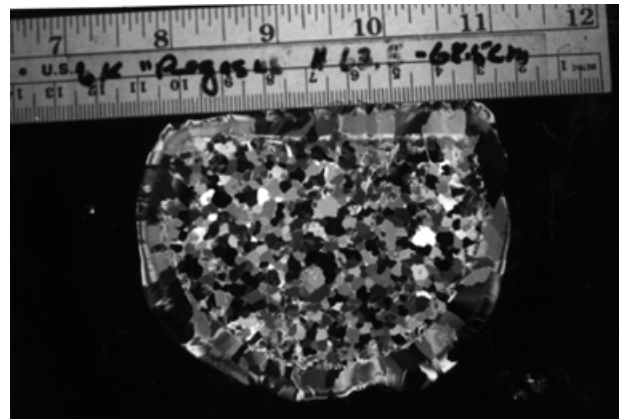
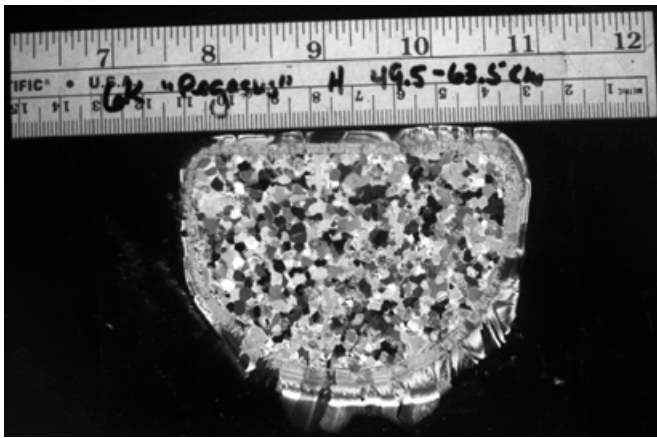

e. 49.5- to 63.5-cm horizon.

f. 63.5- to 68.5-cm horizon.

Figure 55 (cont'd). Horizontal and vertical thin sections of core sample removed from the Pegasus runway surface at the 6000-ft zone.

less than 0.5 to 9 mm (0.02 to 0.35 in.) (Fig. 56). This uppermost layer appears to be firm. In the horizon section at approximately 32 to 34 cm (12.5 to 13 in.) the ice grain size increases and this increase is relatively linear up to a depth of 81 to 86.5 cm (32 to 34 in.). The ice grains are more uniform and the average grain size ranges from 5 to 10 mm (0.2 to 0.4 in.). The origin of this ice also appears to be glacial, but distinctly older as crystals have coalesced to form larger grains. Thin sections were not constructed between 10.5 and 81 cm (4 and 32 in.); these specimens were preserved for shipment to CRREL and compressive strength testing.

At the north end (0 ft) the core between 10.3- and 20.5-cm (4- and 8-in.) depth shows grain sizes from less than 0.5 up to 5 mm (0.02 to 0.2 in.) in diameter and they appear to be somewhat ori-

ented (Fig. 57). This ice also appears to be firm. Above this depth, the ice seemed to be meltwater-derived but the ice was too damaged to construct a thin section.

The gap seen in some cores was also evident at the bottom of the failure zones. The thin gap (0.5–1.5 cm, or 0.2–0.6 in.) had an unknown, but limited, areal extent. Hoar crystals were usually present in this gap. The gap is speculated to result from either coalescing of trapped air bubbles at the water/ice interface during freeze-up of water from the prior season, or from heaving of the upper ice layer when it expands during freeze-up causing arching (Klokov and Diemand 1995). In some cases when the gap was present, it was located at a depth of 25–36 cm (10–14 in.) from the ice surface, while in others it was observed at a depth of 75 cm (30 in.) or more. This gap obvi-

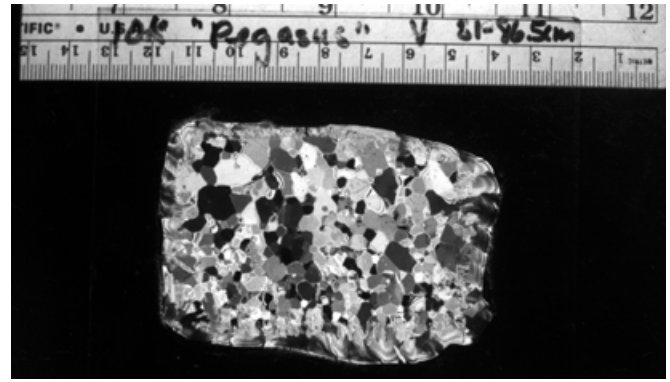
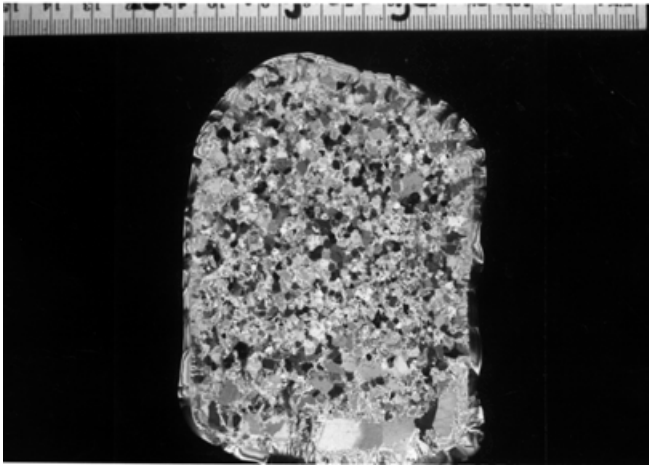
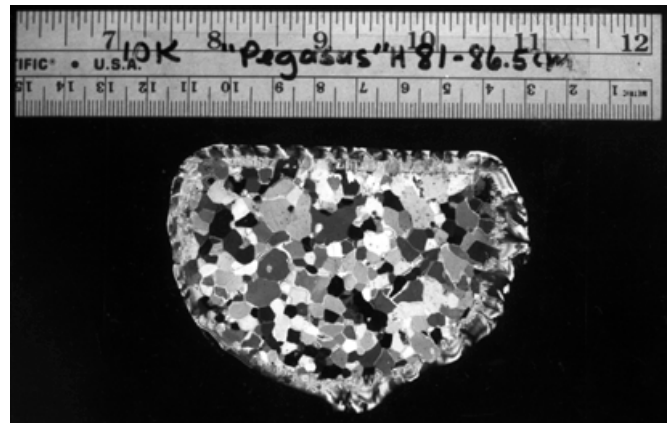
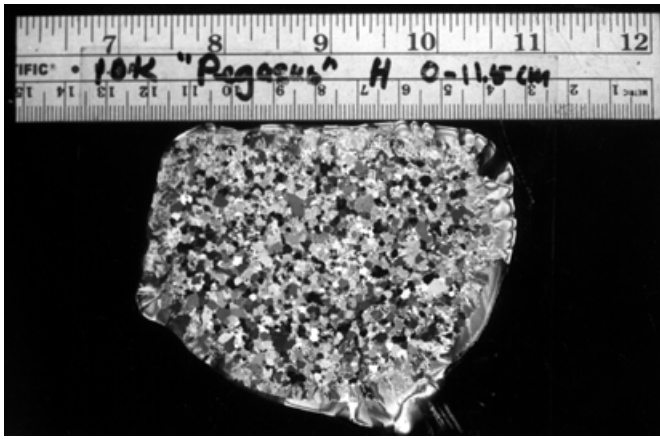

a. 0- to 11.5-cm horizon.

b. 81- to 86.5-cm horizon.

Figure 56. Horizontal and vertical thin sections of core sample removed from the Pegasus runway surface at the 10,000-ft zone.

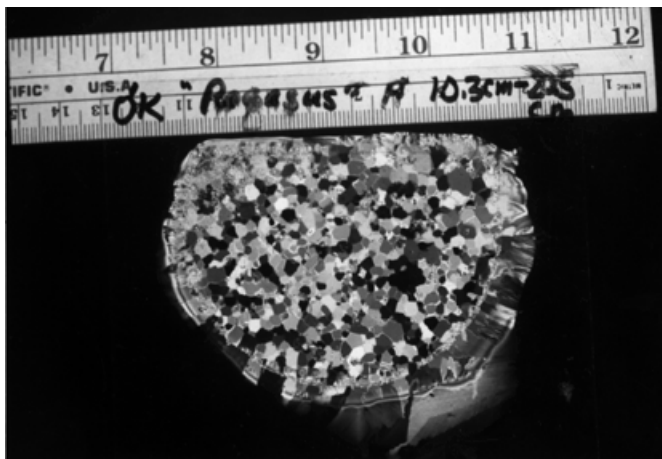

Figure 57. Horizontal and vertical thin sections at 10.3- to 20.5-cm horizon of core sample removed from the Pegasus runway surface at the 0-ft zone (north end).



Figure 58. Dissected ice blister showing gap between upper melt/refreeze ice and lower natural glacial ice.

ously created a local area where the surface layer of ice acted as a beam or plate (Fig. 58) and was subjected to bending stresses when passed over by the proof cart. Some of these locations were clearly too weak to support the concentrated load applied by the C-141 weight on the proof cart.

Our analysis of the failed spots indicated that only a few places existed on the runway that could not support the contact pressure of the C-141 tires. Compared to the actual area contacted by the proof cart tires, only 0.08% of the runway was found to not be strong enough to support the C-141 wheel load (assuming that each of the 40 failure zones were 1 m², 10 ft², in size). It appears that, provided melting does not occur, the temperature cycling process acts to anneal the ice, allowing crystal reorientation, stress relief, and some crack healing while the ice is more plastic. This is a natural process and is often exploited in metallurgy to strengthen some kinds of materials. Unfortunately, it is impossible to predict the degree of strengthening that can occur through this process. Thus, it is best to perform proof rolling at close to the time when the runway will be used. Alternatively, small-scale mechanical test results can be performed at the temperature when proof

rolling was done, followed by thermal cycling of the cores to match what will happen at the runway site, and finally a second set of compression tests at the ice temperature when aircraft will operate.

Following the warmest period of the season at McMurdo, we planned to repeat proof rolling of the Pegasus runway. By mid-December 1992, a management decision had been made not to use C-141 aircraft on the runway during the 1992-93 austral summer season due to its cost. Thus, we reconfigured the proof cart for a C-130. We removed half of the tires and reduced the load on the cart to 88,500 kg (195,000 lb). To save time during reconfiguration, we did not replace the tires on the proof cart. Since the C-141 tires are smaller than those on a C-130, our ability to match the contact area and tire pressure of the C-130 was limited. However, the smaller contact area and higher tire pressure that resulted led to a more severe test of runway strength. The resulting configuration, compared to the maximum allowable loads from the C-130 main landing gear, provided safety factors of 1.3, 1.3, 1.2, and 1.6 for gross load, contact area, single tire load and tire pressure, respectively.

Proof rolling at the C-130 level began on 27 January 1993. After 10 round-trips, approximately 18 m (60 ft) of the center width of the runway had received extensive coverage. An additional 40 ft of width was tracked with a tire-to-tire spacing of about 2 ft. The first round-trip with the proof cart was completed with a tire pressure of 1380 kPa (200 psi). This was done to observe the response to its new configuration of some components of the proof cart. Following this first round-trip, the tire pressure was reduced to about 1100 kPa (160 psi); all subsequent passes were completed at this pressure.

During the first round-trip with the proof cart (1380-kPa or 200-psi tire pressure), two ice failures occurred; each was about 1.4 m² (15 ft²) in size with a depth of about 15 to 20 cm (6 to 8 in.). The failed spots showed broken up ice chunks in the failed area, but the cracks did not extend into the surrounding ice as was the case in November. Sixteen ice failures were experienced during the 42 round-trips (at a tire pressure of 1100 kPa or 160 psi) covering the western 76 m (250 ft) of the 90-m (300-ft) wide runway. These failures were similar to the two discovered during the first pass at 1380 kPa (200 psi). The proof cart was driven immediately adjacent to each side of the failed areas to ensure that all of the weak area was broken. Little or no additional breakage occurred. An additional 12 ice failures were experienced when we proof rolled the easternmost 50 ft of the runway width. These failure spots tended to be similar in nature to the others, but were generally smaller in area and depth.

In all, 30 ice failures occurred during the January proof rolling; none of these were at sites that had been patched in November. All failures were non-catastrophic and showed very little surface expression. When excavated, these failures all were seen to be associated with a thin (6 mm, 0.25 in., or less), near-surface gap containing hoar frost. At each site, the total area of damaged ice averaged 1.5 m (5 ft) in diameter with a depth of 30 cm (12 in.). All failure points were patched, and several of the larger ones were proof rolled again successfully, further confirming the integrity of our patching technique. The runway was thus deemed ready for flight tests by C-130 aircraft (see section on flight tests).

During the following austral summer season, the proof cart was rearranged to C-141 configuration. In early January 1994, proof rolling was begun with a total mass of nearly 136,200 kg (300,000 lb) and a tire pressure of about 1725 kPa (250 psi).

This provided factors of safety of 1.25, 1.4, and 1.3 for gross load, single tire load, and tire pressure, respectively. The proof cart was towed with the 14G grader at a speed of 4 km/hr. The entire runway surface was covered with a tire track-to-tire track spacing of less than 1 m. No failures were found of the type seen the prior year. Several shallow gouges were detected which had been formed by the bulldozer blade used to clear winter-over snow. These gouges were patched. Proof rolling was completed in two days. The runway was certified for C-130 and C-141 operations and opened for air operations on 25 January 1994.

Once a glacial ice runway has been proof rolled satisfactorily, probably to repeated full-scale testing is only necessary if something significant changes with respect to the runway. Such occasions might be 1) if cracks, bumps, or melt features appear on the runway, 2) if different aircraft are considered with potentially more severe landing gear loads, or 3) the runway will be used at a time of year when temperatures will be significantly different than when proof rolling was done.

Other options include, for instance, fabricating a cart or vehicle that duplicates only one side of the aircraft's main gear or even just a single wheel. However, we advise against a single wheel proof rolling device, because the zone of influence (stress) below each tire in a group may overlap, depending on the geometrical placement on an aircraft. This situation would be difficult to accommodate with a single wheel device. Another option may be a static plunger or load piston that could be easily moved about on the runway to test the integrity of a number of locations. This would require "matching" of the plunger's load and contact area with the aircraft tires to allow interpretation of the data obtained by the proof rolling device. Each of these options has some disadvantages, particularly the fact that they will probably require considerably more time to test the majority of the runway surface. However, such devices will certainly be cheaper, smaller, and easier to operate.

PATCHING

In concept, the repair of ice surface defects caused by grader damage, proof cart passage, or natural cracks is no different than patching of potholes in a highway or fixing a decayed spot in a tooth. The damaged or failed area is removed and new material with equal or greater strength

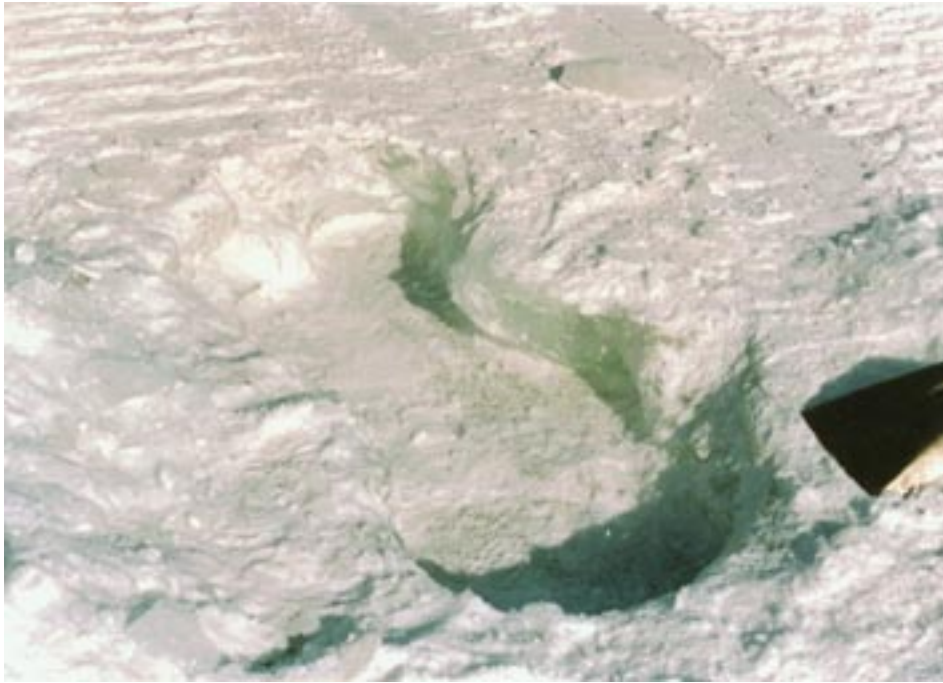

Figure 59. Ice failure site cleaned out and ready for patching.

is placed in the cavity and bonded to the existing material.

We had great success using the procedure outlined below. In all cases repaired areas stood up to the most rigorous proof rolling within 48 hours of patching. The supplies required include a long-handle chisel, a welder's slag hammer or a rock hammer, a coal shovel, and a source of cold fresh water.

1. Empty any loose ice from the area to be patched and place it to the side for later use. Clean the faces of the cavity to allow clear inspection of the ice along the sides and bottom (Fig. 59).
2. Using the chisel, excavate the area surrounding the failure area in order to make certain that all of the weak ice has been dislodged. If a large area of the surrounding ice is weak, use one of the large-scale test methods to break up the weak ice and identify its areal limits.
3. The ice that was removed from the failed area should be further broken up with a hammer into pieces roughly the size of a person's fist or less. The crushed ice should be packed into the cavity to fill the hole slightly above the level with its top by ap-

proximately 7.5 to 10 cm (3 to 4 in.). Any excess ice should be removed from the runway.

4. Slowly fill the hole containing the crushed ice with cold water (ideally very near 0°C) to approximately 75% full. Fill the hole by directing the water around the perimeter of the hole (Fig. 60). Mix the ice-water slurry in the hole with the chisel or shovel by vigorous vertical probing to ensure that all pore spaces are filled with water and to encourage water to flow into any cracks radiating into the surrounding ice. After about an hour, proceed to add water to approximately 5 cm (2 in.) below the ice surface. Smooth the surface with the back side of a shovel. Allow it to cool for 3–4 hours. After this amount of time the surface usually will have frozen over (Fig. 61).
5. Using the chisel, break the top of the ice surface in a number of places (10% of total surface area). Slowly reflood the patch area to fill the air gap under the ice surface with cold water.
6. Use a bright-colored flag (e.g., orange) to mark the location of the patch on the ice surface. A corner of the flag can be frozen into the surface using cold water. If the run-

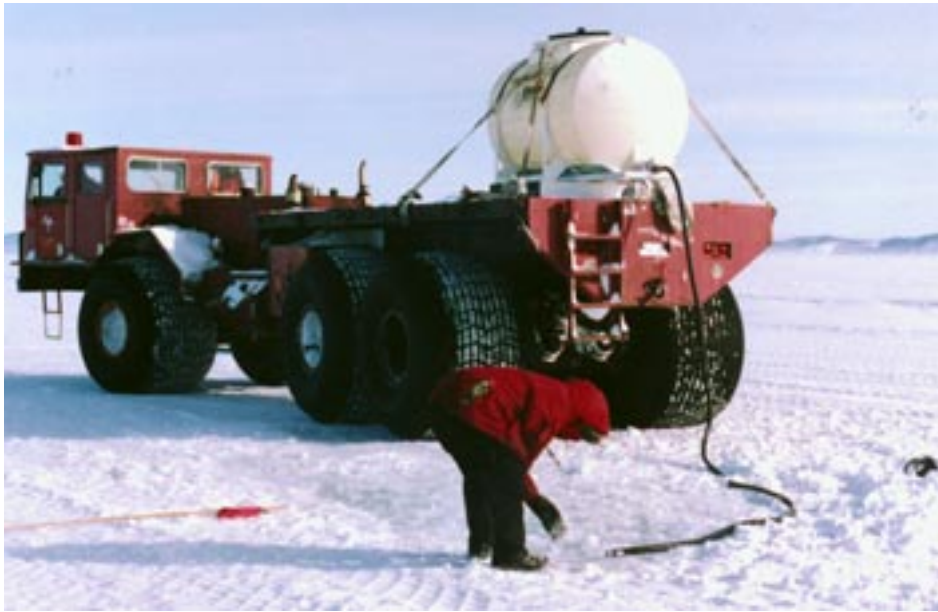

Figure 60. Freshwater filling of cavity during patching.



Figure 61. Freshly patched failure site approximately 4 hours after flooding with water.

- way is not yet in use, a bamboo pole with a flag can be pushed into the ice-water slurry to mark the location.
7. Note the approximate location of the patched area using the runway markers as a guide for the long axis position, and the knowledge of the runway width for the other axis. If air operations are in effect, the airfield manager, the air traffic controller, and the flight crew coordinator should be notified that a fresh patch is on the runway and that this area should be avoided for at least 48 hours.
 8. Allow the area to freeze for a minimum of 48 hours prior to traffic. The flag should then be removed. If possible, the patched



Figure 62. Tracks of proof cart on area patched 48 hours earlier.

area should be “dressed” with the chisel-tooth grader blade to blend its edges into the surrounding ice surface and to provide a uniform surface texture.

9. If there is any question about the integrity of the patched area, this location should be re-certified. This may entail simply taking one or a couple cores at the site to confirm that no voids exist and that a randomly oriented polycrystalline ice has formed in the cavity. If there is any doubt as to the strength of the patched area, it should be proof rolled using one of the methods outlined in the section on full-scale testing (Fig. 62).

ROUGHNESS SURVEY

If a laser-controlled device was used to produce the glacial ice runway surface the degree of smoothness will be far in excess of published standards for aircraft, both in terms of critical short-wave (<3 m) and long-wave (>10 m) bumps. However, if there is any question of the suitability of the runway from the standpoint of rough-

ness, a bump analysis should be performed. This analysis will require that survey data be taken along several lines on selected segments of the runway. The most critical portions of the runway from a bump standpoint are in the touch-down area and leading up to the lift-off area (areas where the aircraft will be traveling at maximum speeds). If only one line of data are to be analyzed, obviously the centerline of the runway should be surveyed. For the majority of heavy aircraft, bumps with a frequency of less than 1 m on a graded runway are inconsequential. Thus, depending on the ice-leveling method used, survey data may be spaced anywhere from 2 m for a crudely leveled ice surface to 10 m for a surface that was laser graded.

We used a “cosine bump” analysis program (Wills 1989) to produce an amplitude vs. wavelength plot (Fig. 63). This provided us with maximum bump heights to compare with the military specification for allowable roughness levels for the C-141 and C-130 aircraft. Figure 64 shows the acceptable levels of smoothness for the C-141 and the bump analysis results for the Pegasus runway following construction.

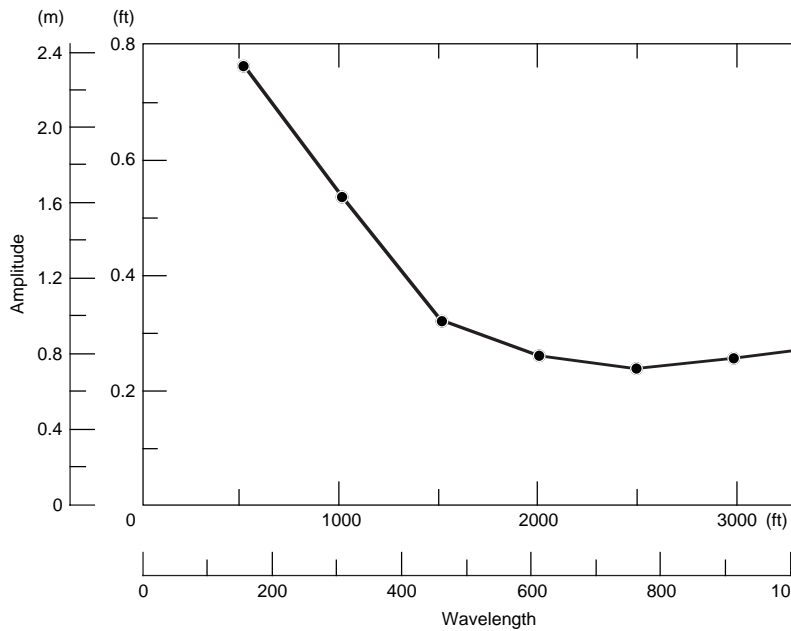

Figure 63. Cosine bump analysis results for finish-graded runway.

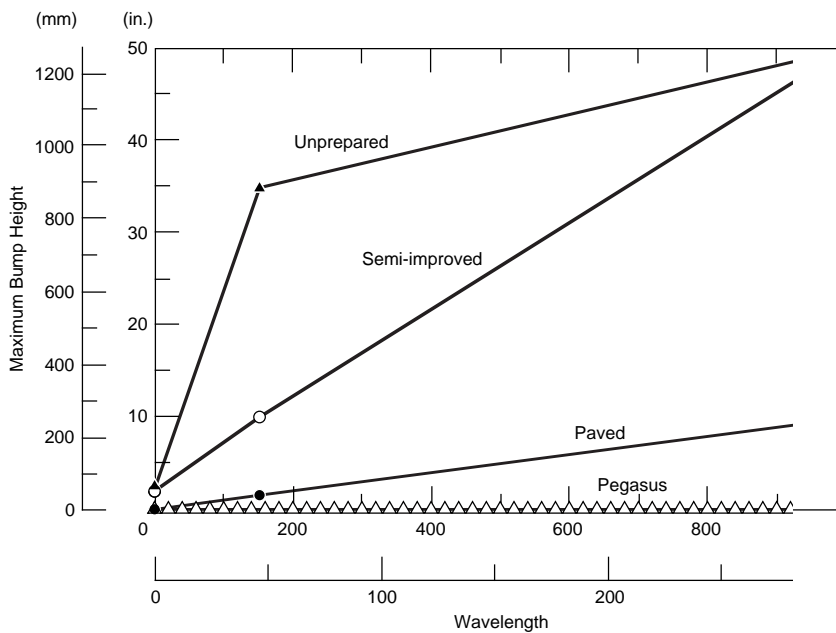

Figure 64. Bump analysis results for finish-graded ice compared to military specifications for allowable bumps on runways.

FLIGHT TEST

A flight test is the only remaining step in certification of the runway for full operations. Pilots, flight operations managers, and facility operators often fall into either one of two minds when it comes to the first landing on a new airfield. Most pilots are optimistic and eager, being captivated

by the aura of being “first.” By contrast, some groups may be overly cautious and very reluctant to try a new ice runway. We found that it was beneficial to include in the progress reports and briefings about the runway construction and certification, from a very early date, all parties associated with flight operations. Encouraging visits to the runway and visual inspection of the run-

way is also advantageous. This allowed them to have a full understanding of what took place to reach the point of calling for a flight test. Further, they had the opportunity to ask questions and to bring up issues important to their role in the development.

A number of goals are associated with flight tests. For the flight crew, it will be an opportunity to establish approach and takeoff navigation information, to become accustomed to the “look” of the runway, and to determine any vagaries of the glide slope. While on the runway, the aircraft should test high-speed smoothness, braking action, ability to make sharp turns, and visibility (surface definition and “dust” blowup). A conservative set of flight tests might include 1) a touch-and-go landing, 2) a “no-brakes” (coast down) landing, 3) a slow speed taxi for the length of the runway, 4) high-speed taxi, 5) hard braking test from high speed and 6) normal takeoff, perhaps from each direction on the runway. We recommend that the first flight tests be performed with an empty aircraft, a polar-experienced crew and perhaps a member of the construction team, most desirably the field engineer. If polar crews are not available, a minimum requirement is that the crew have rough-field experience and they be extremely familiar with the type of aircraft being flown. In most situations, the aircraft used for the flight test should be of the type that will be the primary user of the runway. However, it is possible, and sometimes prudent, to use a robust, but less valuable, aircraft to establish the pertinent characteristics of the runway. If this option is chosen, the test

flight aircraft should be of a type that allows confident extrapolation of results to the aircraft that will ultimately use the runway (i.e., don’t use a Twin Otter to check for the suitability of the runway for a C-141).

A weather observer, trained in aviation meteorology, should be on site to monitor winds and visibility before the test aircraft taking off from its base of operation. The observer should establish the weather trend at the site and make frequent reports (hourly) to the flight crew to ensure that they are fully informed on conditions at the runway. The observer must remain on site, making measurements and communicating with the flight crew from the time the aircraft reaches its inbound point of safe return (PSR) until it passes PSR on the outbound flight.

For the test flight, crash/fire/rescue resources should be on hand, just as would normally be present at any airport. In addition, some aircraft maintenance capability and fuel on site may be a good precaution.

The first flight should never be a test of the ability of the runway to support the aircraft load. Full-scale tests must be adequate to leave no doubt in anyone’s mind that the runway will easily support the design aircraft. This will be known to all involved parties, but it would be wise to ensure that anyone who has not participated in the process of development (e.g., journalists, public relations people, visitors, camp workers) also understands that the question of the bearing strength of the runway has already been answered.

Following the flight test, the pilot should brief



Figure 65. LC-130 operating on wheels during runway testing of Pegasus in February 1993.

the runway construction team and the facility managers on the impressions and findings from the event. Any physical or operational concerns should be discussed fully and any problem areas should be identified. A plan should be made for rectifying any concerns. This will be followed by setup of the appropriate infrastructure and support functions for full flight operations and a schedule for working flights.

The flight test at Pegasus was very conveniently accomplished with one of the LC-130 aircraft operating out of Williams Field skiway. On 6 February 1993, a Hercules departed from the skiway with only a flight crew on board and landed at Pegasus on wheels (Fig. 65). The landing weight was 47,700 kg (105,000 lb). Taxi, steering, and braking tests were performed. The pilot reported that the aircraft was very controllable, and that the runway was comparable to the sea ice runway at McMurdo (operated between approximately 1 October and 15 December each year), perhaps somewhat smoother. The aircraft was fueled to increase gross weight and to practice fueling procedures at Pegasus. The plane taxied on skis for a short distance to determine the suitability of the runway to support ski operations if necessary. The pilot felt that skied landings and takeoffs were certainly feasible from the runway.

A wheeled takeoff was then completed at 55,400 kg (122,000 lb), followed by a high speed touch-

and-go and then a full-stop landing. Finally, a takeoff to the north (all previous landings and takeoffs were to the south) was performed and the aircraft returned to Williams Field. No control problems were experienced at any time and the runway was deemed to be very suitable for wheeled operations.

Complete runway surface inspection, both from the cockpit and from personnel on the ground, showed no evidence of any damage to the ice surface (Fig. 66). The plane deliberately taxied at slow speed over a patched area with no negative consequences. The Pegasus glacial ice runway was opened on 7 February 1993 for wheeled (L)C-130 flights.

Operational tests for a C-141 took place the following season, on 7 February 1994, when a USAF C-141 flew from Christchurch to a landing on the Pegasus glacial ice runway. The plane weighed 104,400 kg (230,000 lb) on landing. It touched down exactly at the north-end zero threshold and had reached a slow taxi speed within 6000 ft using wheel brakes and a slight amount of reverse thrust. Snow billowing was not a problem. Between 2.5 and 7.5 cm (1 and 3 in.) of processed snow cover was present on the ice surface. The small, high-pressure tires appeared to displace the snow only where more than 5 cm (2 in.) were present or where prior C-130 wheel tracks had existed. The C-141 taxied



Figure 66. First tracks of aircraft tires on newly constructed glacial ice runway.

the full length of the runway and executed its turn-around at the south end without difficulty. The plane slowly taxied back to the ramp at the north end and again turned fully to align with the fuel pit on the west side of the ramp. Some front wheel skidding occurred during this sharp turn.

Conversations with the pilot and his crew indicated extreme satisfaction with the runway. The

remarkable degree of smoothness was consistently mentioned; observers at the 5000-ft mark could detect no wing deflections at touch-down or during run-out. The aircraft was fueled and loaded with priority science cargo totaling 13,325 kg (29,350 lb) plus 54 passengers (cover photo). It proceeded with takeoff (Fig. 67), pulling clear of the runway at the 5000-ft mark. The runway suffered no damage from the C-141 operation.



Figure 67. C-141 takeoff from the Pegasus runway following successful tests in February 1994.

CHAPTER 5. MAINTENANCE

A site chosen at a natural blue-ice field at high latitude may require essentially no maintenance short of cleaning up any contaminants that drop onto the ice. Snow management will likely be the most important maintenance issue associated with the majority of glacial ice runways. We see this to include both protection of the runway from melt problems and protection against snow accumulation and inundation. The goal of runway maintenance should be to preserve the natural balance of conditions at the site. If properly sited, the runway will be able to reside at this location in usable form with an absolute minimum of perturbation from what would happen at the site if it was uninhabited. To do otherwise is unnecessary and inefficient. In polar regions, huge amounts of energy are required to maintain an area the size of an airport at a state other than natural.

PERSONNEL

The number of persons required to maintain a glacial ice runway will vary considerably according to the site and its environmental characteristics. Further, variations may exist from year to year, and at times throughout the year. These latter variations in required workforce size cannot be anticipated with any degree of accuracy, and a flexible workforce might be best suited for the site. However, this will only work if the collateral duties of the flexible members of the workforce are not also dictated by adverse weather. We discovered that it was almost always the case that when the Pegasus runway required a large effort, as did many other facilities in the McMurdo area, and that personnel who might normally be available to assist us were frequently occupied with other important tasks.

A site supervisor will be essential. In the case of a polar camp with multiple airfields (e.g., McMurdo), it may make sense to have one individual supervise all runways so that decisions can be made with a attitude toward what is most beneficial for the entire polar program.

For the Pegasus facility, we recommend two full-time maintenance personnel with intimate knowledge of the site. There should also be access to one or two other operators who can be available when storms and drifting snow occur. The maintenance staff should also include a half-time mechanic/fabricator. In addition to usual equip-

ment maintenance, this person will be responsible for making sure that all vehicles are clean and free from any fluid leaks.

The maintenance crew and supervisor should have unrestricted access to persons familiar with snow and ice science and to the body of literature on this subject. Consultation with specialists will greatly assist in dealing with these issues in a timely manner so that action can be taken as soon as possible. This can often significantly reduce the amount of work necessary to respond to unexpected conditions and may mean the difference between maintaining and losing the runway in a given season. It will certainly extend the life of the runway.

SNOW MANAGEMENT

Obstacles, even small surface features, can trap snow and initiate accumulation. Depending on the need at the time, runway maintenance personnel will either want to encourage or limit this behavior. At the Pegasus site, we identified several means of encouraging snow accumulation when it was in our interest to cover an area of exposed ice on the runway surface. The most controllable method was to generate small windrows, spaced a meter or so apart, perpendicular to the direction of the prevailing wind. Depending on the amount of loose snow available in the area and wind speed (which governs the amount of snow carried by the wind), these windrows will trap on their lee side an amount of snow at least equal to the volume of the windrow. Windrows can be produced by using a grader, or more efficiently, a windrow drag such as we fabricated (Fig. 68).

Once the windrows were "full" we found that it was necessary to level the area (using snow planes or drags; Fig. 69, 70, and 71) and to compact the snow using a pneumatic-tire roller (Fig. 72). By compacting the snow onto the ice or existing snow surface, it became bonded to the surface and dense enough to resist wind erosion. We found that, even using heavy rollers (35–50 tons or 32–45 tonnes, with greater than 690-kPa or 100-psi tire pressure), compacting was important as soon as the snow reached a depth that resulted in a compacted layer of no more than 10 cm. Compacting more snow than this results in a strong density distribution in the compacted layer which



Figure 68. Windrow drag used to encourage snow accumulation.

makes it much more susceptible to deterioration when temperature gradients are present across the snowpack. Following leveling and compaction, we set a new series of windrows to begin the process again. In this manner, on a day with steady winds carrying considerable snow building up over a half meter of snow was possible in a 24-hour period.

To add to the snow cover when snow is falling and there is little or no wind, it is best to compact

the fallen snow at regular intervals in the areas where accumulation is desired. We used I-beam drags (Fig. 73) with a degree of success, but a pneumatic-tire roller is preferable.

If the goal is to avoid snow accumulation, several approaches may be taken depending on the amount of wind present. When conditions are calm and fresh snow has fallen, the area should remain untouched where additional snow is not wanted. Often, this snow will quickly be removed



Figure 69. Small snow plane with minor height adjustability.



Figure 70. Medium snow plane with height and blade attack angle adjustability.



Figure 71. Long-base (12-m, or 40-ft) snow plane with height adjustability.



Figure 72. Heavy (45-tonne or 50-ton capacity) pneumatic-tire roller.



Figure 73. Drag made from heavy I-beam.

naturally as soon as moderate winds return. Even if winds do not come up, the loose snow will rapidly dissipate via evaporation and melting if there are warm temperatures and intense sun.

When snow accumulation is undesirable, and windblown snow is being trapped on the runway, we found that it was best to drag and plane the runway nearly continuously to break up drift pods as they formed. By removing the features that trap drifting snow, and keeping the surface snow loosened, most of the snow would either remain in the wind stream or be picked up by the wind and carried out of the area of the runway. During windy conditions, any device that loosened and broke the surface layer of snow into small pieces would enable the wind to pick it up and carry it away.

The shelters and fuel tanks at the runway will naturally attract snow drifts. This is nearly unavoidable, unless these facilities can be placed on stilts. In many cases (as at Pegasus), the runway infrastructure will be on site only seasonally, so elevated buildings may be unattractive and too expensive. The camp infrastructure should be situated, relative to the runway, where it is least likely to generate drifts that impinge on the runway. Individual structures should be aligned along a line perpendicular to the strong wind direction, so that when large drifts do occur, they do not fill up the space between buildings. Cleanup (snow removal and surface smoothing) around the runway facilities will be required after most storms, but this effort can be minimized by having the infrastructure sled-

mounted, or at least equipped with sledge-like bottoms.

Runway markers and flag lines also provide a collection site for snow. Markers should be kept to an absolute minimum. Snow that does collect around flag lines and markers should be removed or spread so that these obstacles do not become surrounded by an “island of snow.” This will lead to accelerated snow drifting in the future. We used drags and planes to keep the snow along the flanks of the runway shaped to limit drifting, including close attention to the area around markers and flags. Operators could only get within a few meters of these obstacles using heavy equipment, so we cleaned around the flags and markers with hand shovels before using large devices.

If snow accumulation is not desired, scarps or sharp elevations changes should be avoided between snow and ice or anywhere on the snow surface in the immediate vicinity of the runway. These will fill with snow and a drift may extend for as much a 10 times the height of the scarp.

RUNWAY SMOOTHNESS, SURFACE DEFINITION, AND FRICTION COEFFICIENT

Feedback from flight crews will provide the most useful information on the integrity of the runway surface. Maintenance personnel should establish frequent communication with all of the

pilots who use the runway in order to obtain an accurate picture of the range of tolerance and desires. The surface features that we found to be of most concern to aircraft personnel include the very short wavelength smoothness (frequency on the order of 1–10 cm), coefficient of surface friction, and the ability to visually distinguish the runway surface (surface definition).

The process of grading will leave the ice with a rough surface when viewed on a small scale (Fig. 38, 47). Tires traveling over this surface at high speed will produce a vibration and noise that we found was undesirable to some of the (L)C-130 flight crews. A thin cover of snow, even if it is uncompacted, will alleviate this problem. A thin cover of snow is also useful as a “wearing surface” for the runway. Dirt, exhaust soot, tire wear dust (from takeoffs and landings on paved runways), and any other spilled or dropped contaminants can be easily removed when deposited on the wearing surface and fresh snow added. However, the thin snow cover should never exceed a depth of 6 cm to avoid overstressing landing gear. It is best to drag or plane this wearing surface once a day or after every aircraft operation to remove any tire tracks.

At natural blue-ice sites, the completely exposed glacial ice often has a cusped surface as the result of ablation (Fig. 74). This type of surface will generate noise and high frequency vibration in fast-moving aircraft but this is nearly unavoidable. Moving snow to the runway to fill the cusps



Figure 74. Exposed ice (blue ice) at inland locations.



Figure 75. Conventional C-130 performing routine landing on the glacial ice runway.

at a typical blue-ice site would be difficult and the snow could not be kept in place anyway, since blue-ice sites are usually quite windy and dry. Another possibility is to grade or grind the ice surface, but this may not make the ice any smoother on a small scale.

The greater the surface definition, the better will be pilot's ability to gauge the horizon of the runway. We found that the surface left in the ice by the chisel-tooth grader blade was very well defined. On clear days, pilots reported picking out the Pegasus runway from over 100 km away. Most of the time, however, we kept a thin cover of snow on the runway and this reduced definition considerably. Frequent dragging and planing of the surface kept the snow roughened and fresh. This did provide a significant contrast to the surrounding snow surfaces and, in all but the worst lighting conditions, was adequate for comfortable landings (Fig. 75). The roughened snow surface at Pegasus was reported to be much more defined than the skiway at Williams Field.

Maintenance of a modest coefficient of friction on the runway surface is important for aircraft braking, steering and lateral stability. In general, a coefficient of at least 0.25 will be present on any glacial ice runway surface when the temperature is less than -10°C . Concern for low levels of friction should arise at temperatures warmer than -5°C . Snow is capable of providing a higher coefficient of friction than ice at warm temperatures. Keeping the snow surface roughened by dragging and planing will provide the maximum possible friction level. In all cases, one should not allow a surface sheen (thin, impermeable ice layer)

to develop. Not only will this drastically reduce friction, it will facilitate subsurface deterioration due to trapped heat from loss of permeability and significantly reduce surface definition.

Periodically resurveying the centerline of the runway and performing a long-wavelength bump analysis is recommended. At most sites, natural changes in the topography of the glacier will happen slowly over the span of many years, but glacial forces may be high in some locations, and long-wavelength, low-amplitude swales may appear on the runway within a few years of its construction. Since regrading of the segments of the runway where high spots occur will be required if this occurs, we recommend that this type of major maintenance be performed during a period of the year when there are no flight operations. If this is not possible, performing grading and cleanup of discrete areas within the non-operating windows is manageable during the day or week if the flight schedule is not too heavy. If more than 0.3 m of ice is removed in any area, we recommend that area be proof rolled since untested ice will be brought within the surface zone where aircraft tire stresses will challenge its strength.

SURFACE CLEANLINESS

The importance of keeping the runway surface and adjacent areas clean can not be overstated. Nearly any matter other than snow that lies on the surface will promote deterioration. Common contaminants include fuel and lubricants, ice

chunks, dirt and other mineral matter, trash (building materials, paper, plastic containers) and soot from aircraft and equipment engines. The best approach for dealing with contaminants is to avoid getting them on the runway in the first place. This will only be possible for some types of foreign matter, while others may be impossible to completely control.

We advocate a regular program of runway inspection with daily observation of the majority of the runway surface (as is done at conventional airports). Adjacent areas should be inspected at least weekly, except during any periods when air temperatures are near melting; then they should also be viewed daily. Any contaminants discovered during these inspections should be picked up completely and disposed of in an environmentally sound manner.

Small spills of fuel or lubricants on the ice will often require specialized cleanup procedures. Cleanup kits designed specifically for hazardous fluids are available and should be on site for these occasions. Most established polar camps have personnel trained for such cleanups, and these individuals can in turn train runway maintenance personnel in the proper procedures for recovering spilled oil, fuel, coolant, or other fluids. After cleanup, chipping out the ice in the area of a spill may be necessary in order to completely remove the contaminant. This ice should be disposed of properly along with the cleanup fluids. Using the patching procedures outlined above, the cavity can then be repaired.

Because of their lower reflectivity, chunks of ice on the runway can also represent a threat. This is especially true for ice chunks that may have formed on runway equipment and fallen off. These ice chunks may contain many other types of contaminants as well, having picked up dirt, oil, grease and other foreign substances from the vehicle. Lying on the surface, even an uncontaminated lump of ice will absorb considerable solar radiation through its large surface area and will warm significantly. During the peak of summer, this can easily lead to the beginning of a melt site that will progress into the surface of the runway. Ice chunks along the flanks of the runway will behave in the same manner. If snow is present in this area, it is advisable to attempt to bury the ice pieces in the snowpack. This can be done with a ripper (Fig. 30) or by using drags, planes, or rollers.

Windborne mineral matter can be very problematic. At the Pegasus site, occasional strong

winds from the southwest carry sand particles from Black Island over the runway. Observation of ice and snow cores in the area include numerous horizons of concentrated mineral particles (Fig. 15 and 16), suggesting that this is a regular occurrence (on the order of less than once per year to several times a season). Areal reconnaissance in the area between the Pegasus runway and Black Island shows that plumes of dirty snow and ice can be clearly identified pointing in a generally northeast direction. We have also been present at the runway on several occasions when strong winds were blowing and witnessed sand "marching over the snow surface like a massive army of ants." Such contamination of the runway is impossible to clean up. And, it can be devastating just prior to or at the time of peak temperatures and solar intensity.

We discovered that a runway can be quite well protected from such contamination by wind borne deposits by using "snow fence" techniques. If it is known from what direction such mineral particles will come, blocks can be created upwind from the runway. At the Pegasus site, we observed that the mineral particles traveled by saltation (were never carried for long periods of time in the wind column), even when very strong winds were present. Thus, the sand particles bounced along the snow surface and often would become trapped by very small snow scarps (Fig. 18). Being almost too heavy to transport with the available wind, we discovered that gently sloping berms of moderate height aligned between the runway and Black Island were adequate to stop the forward progress of most of the sand. Extreme cases may exist in other areas where larger berms or manufactured snow fences (probably with narrow openings) will be required to remove mineral particles from the air stream before they reach the runway. However, windborne contaminants should not be a major or frequent problem at most runway sites, since the damage they cause would have been obvious during initial site evaluation and the site would have been removed from consideration.

A smooth runway surface will be best suited to resisting entrapment of sand when it is impossible to avoid wind blown mineral dust. Ideally, most of the particles will continue to be transported past the runway surface. When mineral particles do contaminate the runway surface there are only a few options available. If, as in most cases, there is a small amount of snow on the runway the mineral dust should be mixed into

the snow as soon as possible. Frequent dragging and planing will accomplish this and will limit the solar heating of individual sand particles.

PATCHING OF ICE DAMAGE AND FLAWS

Whenever cracks, gouges, broken or weak ice are discovered on the runway they should be patched as soon as practical. Patching is best performed when the air and ice are cold (less than -10°C). However, if the damaged or flawed area appears to represent a safety hazard to aircraft, it should be repaired immediately. Even when conditions are warmer than desirable, the procedures outlined in the patching section will be effective in fixing the ice. (When patching small areas during warm and sunny periods, it may be advantageous to shade the patch site from the sun, provided there is plenty of allowance for air flow.)

PREVENTING OCCURRENCE OF MELT FEATURES

Natural surface and subsurface melting are not singularly attributable to the local ambient temperature. The potential for melting is a complex combination of the angle of inclination of incoming radiation (which directly determines the ambient temperature), the amount of reflected radiation (attributable to the surface characteristics), the absorption and transmission of the nonreflected radiation, the magnitude of convec-

tive cooling at the surface, and conduction to the free surface. Different surface material types will have different properties which cause them to respond uniquely with regard to these factors.

During initial reconnaissance of the site, features in the region of the Pegasus runway alerted us to the fact that natural melting (both surface and subsurface) was not uncommon at this site. In addition, subsurface melt pools are reported in the literature (Paige 1968, Mellor and Swithinbank 1989). During the 1991–92 summer season, formation of a subsurface melt pool was witnessed by the Pegasus construction team. Paige’s discussion is limited to speculation on the physics involved in melt pool formation, since he did not document the actual formation process. Subsurface melting could occur due to the absorption of radiation at some depth in the ice by a foreign substance (dirt or rocks) or by the trapping of emitted longwave radiation in an air bubble. The most likely mechanism for subsurface melting is the convective cooling of the ice surface such that absorption of radiation and heating are occurring at some depth in the ice instead of initiating at the surface. The presence of absorbing media or bubbles would then serve to enhance and accelerate the process of subsurface melting.

By trial, we discovered that natural melt features could be prevented at the Pegasus site by completely covering exposed ice surfaces with 30 cm (12 in.) of snow at a density of $0.35\text{--}0.45\text{ g/cm}^3$. Later, we initiated a study of the radiation balance at the site. Our field results were easily confirmed by calculating radiation transmission in snow. Shortwave radiation penetrates the snow-

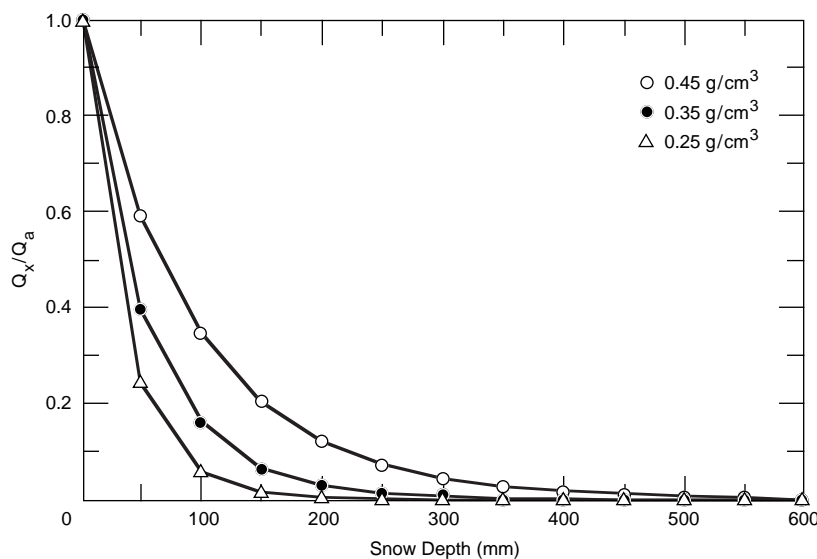

Figure 76. Ratio of shortwave solar radiation at depth x in the snowpack (Q_x) to shortwave solar radiation absorbed at the snow surface (Q_a).

pack as an exponential function as described by

$$Q_{sw,x} = Q_{sw,a} e^{-\mu x}$$

where $Q_{sw,x}$ = flux of shortwave solar radiation at depth x in the snowpack,

$Q_{sw,a}$ = flux of shortwave solar radiation absorbed at the snow surface,

μ = bulk extinction coefficient.

Figure 76 shows the ratio of solar intensity absorbed at various depth in the snowpack to the intensity absorbed at the snow surface as a function of snow density by using the following bulk extinction coefficient (Fig. 77), which neglects spectral dependence:

$$\mu_i = \frac{-1}{Q_{sw,x} \cdot (dQ_{sw,x}/dx)}$$

Ice deterioration (melting) is due to the absorption of internal energy being greater than the combination of loss of energy by conduction to the free surfaces and convection at the free surface (Fukami and Kojima 1980, Ashton 1984). At Pegasus, about 30 cm of mid-density snow (0.35–0.45 g/cm³) is adequate to dissipate radiational heating potential given the boundary conditions (ambient temperatures, ice temperature at depth, and angle and duration of solar input).

As a simple tool for maintenance personnel at Pegasus, we used ambient temperature records (Fig. 78) as a basis for decisions about runway protection. By following the trend of the average

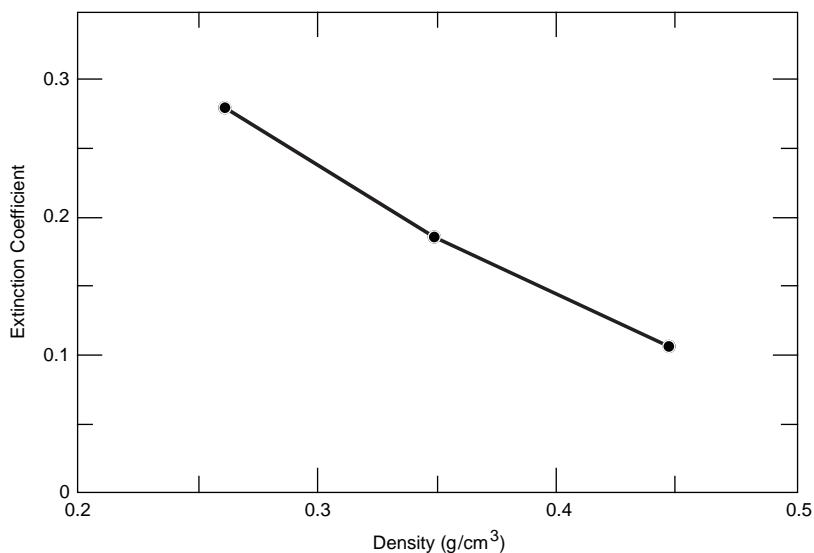

Figure 77. Bulk extinction coefficient for snow.

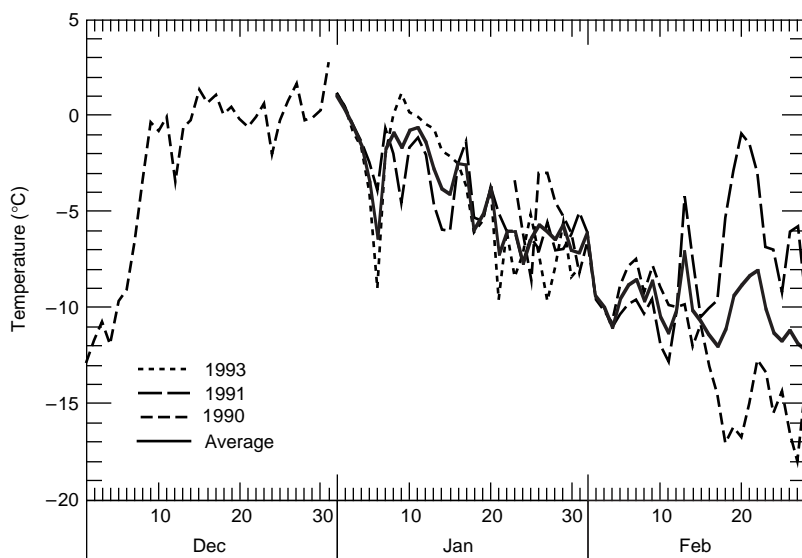

Figure 78. Ambient temperatures recorded at the "Pegasus North" AWS.

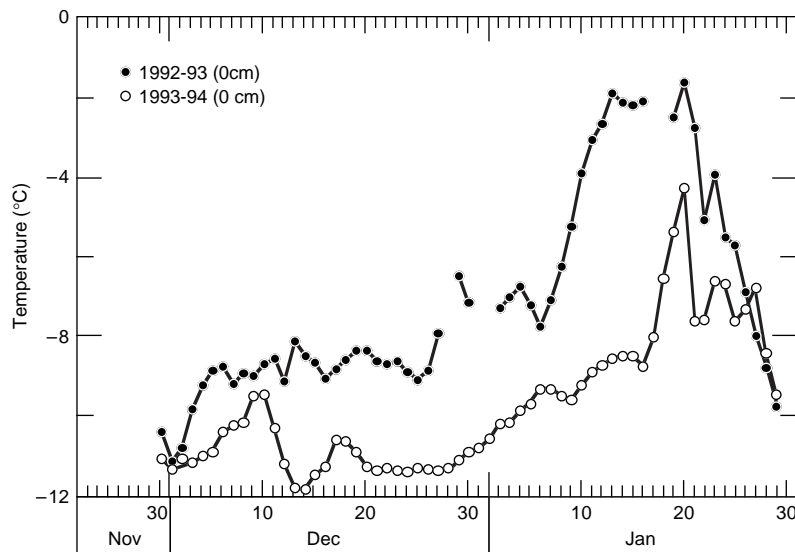

Figure 79. Ice surface temperatures at 2000-ft marker on the east edge of the runway throughout the 1992–93 and 1993–94 austral summers.

daily air temperature and comparing this with the temperature profiles in the runway ice (Fig. 79, App. D), we set the latest time to begin depositing snow onto the Pegasus runway to prevent melting and, after the peak of summer, the time to remove snow from the runway in order to start air operations. At Pegasus, our basic guidelines were as follows: placement of snow cover should be completed by the time air temperature has risen to an average daily value of -10°C (for a span of three or more days) or ice temperature (the highest recorded value in a 1-m vertical profile) has risen to -15°C , whichever occurs first. The beginning of snow removal activities is triggered, after the seasonal cooling trend is clearly established, by the average daily air temperature reaching a value less than the highest ice temperature (measured that day in the ice column). Characteristically, this translates to placement of the snow cover by about 15 November and removal about 7 January (Fig. 78 and 79). However, the decision to strip the runway of its snow cover and commence/cease flight operations must be determined by the ice surface temperature and temperature profile in the ice (App. D).

Thermocouple strings were installed during the season of 1992–93 at the 2000-ft, 4000-ft, 6000-ft, and 8000-ft positions along the runway. These should be connected to some type of datalogging equipment. Reading thermocouples on a daily basis is insufficient as the ice surface temperature fluctuates quite dramatically. The average daily ice surface temperature must be less than or equal to -5°C . Retaining a record of the ice temperature profile is critical as decisions must be based on

past and current trends. For example, during 1992–93 the ice temperatures were too high for flight operations to begin until around 21 January. During the 1993–94 season (thermocouple strings installed at 2000 ft, 5000 ft, and 8000 ft) the ice temperatures were lower and operations could have begun as early as 17 January (see Fig. 79 and App. D). Also, the ambient and ice temperatures can be as much as 2 degrees warmer on the north (340°) end of the runway. As landing and refueling take place on the north end, having different locations along the runway for monitoring temperatures is important. It is not sufficient to “guess” that the season had been colder than normal. Although the ice temperature does respond to ambient temperatures by conduction, predicting the ice surface temperature is impossible, as convection and radiation also play dominant roles in the heating/cooling of the ice surface. The overall surface heat budget determines the ice temperature and an approximate date for the heat budget becoming neutral and then negative is 21 January. There is no way to assure safe flight operations without this information as the runway has only been proofed for “cold” ice. The ultimate strength of ice is reduced drastically at higher temperatures.

Furthermore, these guidelines for snow cover and removal are based solely on the simplified estimation of solar radiation penetration as presented above. Spectral detail has also not been considered. Snow grain size is also a factor in finding the penetration depth of solar radiation (Brandt and Warren 1993). Conduction by the snow to the ice surface and convection at the

snow surface have not been taken into consideration; a higher density snow will also conduct more heat to the ice surface than a lower density snow. The actual heat budget at the Pegasus site has not been studied in detail, but we feel that these guidelines are probably conservative. The Pegasus site was originally chosen because of the relative absence of melt features. As indicated in the section describing the site selection process, the natural snow cover at the Pegasus site prior to construction was approximately 30 cm (12 in.).

Possibly, other materials may suffice to protect a glacial ice runway from melt problems. We briefly considered alternatives, including gravel and artificial materials (e.g., plastics, metallic foil, etc.), but these would have required considerable study, environmental assessment, cost, and logistical challenges. At sites with an inadequate supply of snow, such alternatives may warrant more serious consideration.

Melt features may also form due to introduction of foreign objects. The substances mentioned above in the section on surface cleanliness will all accelerate the process of solar heat-up that can easily lead to melt problems. In addition to those mentioned previously, objects such as runway markers and flag lines will also act as heat sinks and can initiate a melt site. Once melting has been started, if there is no significant drop in the ambient temperature or solar intensity, the site will become unstable and melting will accelerate. We advocate using only the absolute minimum of markers on or near the runway. Markers should be of as little mass, and made of materials that are as nonconductive, as possible. It is also very helpful to have the markers located at least 18 m off the edge of the runway and surrounded by snow with a smooth surface.

Requirements for protective snow cover

For some runway sites, temperatures and solar radiation intensity will not be at a level where melt features are possible. Obviously, no protection is required at such locations and maintenance will be far simpler.

The intent of placing a snow cover on the glacial ice runway surface is to protect it against excessive radiational heating that could cause melting. In most cases, the protective cover will be temporary, being in place only for a single critical period in the season. This period of time will be governed by the individual site, and includes more than just the time when the sun

and ambient temperatures are at their very peak. Snow and ice, and any foreign matter they contain, act like capacitors and will respond with a heating or cooling lag compared with the ambient conditions.

For the most part, the runway will be unable to support wheeled aircraft during the period when the protective snow cover is in place. Processing the protective snow cap to a density and strength adequate for some aircraft may be possible, since it is fairly thin and has a very rigid underlying base. For example, at Pegasus in most seasons the snow cap could be compacted with heavy pneumatic-tire rollers, bringing it to a strength that would support the 690-kPa (100-psi) tire pressure of the C-130 Hercules. If the protective cap can be made strong enough to support the aircraft type that will principally use the airfield, consideration should be given to making the snow cap permanent. This will avoid the need to annually place and remove the snow cover and thus drastically reduce operating cost and complexity and the potential for additional problems (e.g., snow collection, long-term buildup of snow on the flanks of the runway). The topic of compacted snow runways will not be covered here, but can be accessed in Blaisdell et al. (1995), Russell-Head and Budd (1989), and other publications.

Ski-equipped aircraft, such as the LC-130, can, of course, use the runway throughout the period when it is covered. This may be somewhat advantageous, but obviously does not make use of the high bearing strength of the underlying ice and negates the reason for constructing the runway in the first place. By using ski-equipped aircraft during the period when the snow cover is in place, valuable flight days in a short operational season are not completely lost.

If air operations (skis or wheels) do occur on the runway while the protective snow cover is in place the surface must be smooth and free from long-wavelength bumps. This may be challenging to accomplish, since the grader may not have adequate flotation to operate on the snow surface. A device like our 12-m (40-ft) snow plane (Fig. 71), but equipped with a laser-level system, would allow adequate smoothing.

As mentioned above, we determined at Pegasus that 20–30 cm (8–12 in.) of compacted snow was necessary on the ice surface each year from about 10 November to about 7 January in order to completely avoid melt problems. Using this system, maximum ice temperatures of about -5°C were reached at a depth of 5–10 cm (2–4 in.) in the



Figure 80. Adjustable skids used to assist in “floating” grader blade.

ice on or about the beginning of January. During our first operational season (1992–93), construction was not completed until the end of October. We used the snowblower, operating along the flanks of the runway, to move a snow/ice mixture back onto the runway for protection. The bulldozers and grader with skids (feet) (Fig. 29 and 80) were used to spread the snow uniformly over the ice surface. This operation required about three weeks to complete. Thus, based on our guidelines, we were about 10 days late in getting the snow cover in place. This created considerable concern which was compounded by the high ice-chunk content in the protective snow cover. (The snow blown back onto the runway came

from the immediate flanks of the airstrip and thus had a high concentration of ice chunks that had been removed from the runway during construction.) We used the heavy pneumatic-tire roller to compact this snow in 10- to 15-cm lifts; this also acted to mix well the ice and snow so that the ice chunks were more uniformly distributed throughout the cover. The surface was planed and dragged to leave a smooth and porous surface.

The 1993–94 season at Pegasus was more typical of what we expect would be a normal operational year. Because the annual sea ice runway at McMurdo provides economical access for wheeled aircraft at the beginning of the season, the Pegasus runway is not required until after about 15 December. Thus, the snow that covers the runway throughout the winter, and any extra snow that is encourage to collect between early September and late November (if it is needed) remains on the runway until it is safe to remove based on the guidelines established for prevention of melt. By using natural means of snow collection, much less effort is required, but attention must be paid for a longer period of time.

A survey of the runway snow cover in late August 1993 indicated that the winter had provided an average of about 30 cm (12 in.) of snow. However, this snow was in

no way uniformly distributed. The centerline was exposed along nearly the entire length of the runway. Along the edges, the runway had tapered drifts that diminished in height as they extended toward the centerline. Many small drift pods (<10 m²) were randomly scattered across the remainder of the surface. In addition, the south half of the runway had notably more snow accumulation than the northern portion. We used the ripper with skids (Fig. 30) to loosen the drift snow. This was followed by the grader and bulldozers with skids, and then the snow plane and drags, to redistributed the snow and smooth the surface. This process took about two weeks to accomplish using a crew of four persons.

We did not mechanically add any more snow to the runway. We assumed that some additional snow would accumulate on the runway during spring storms and, by using the methods outlined in the section on snow management, we planned to add, decrease or maintain the depth of snow cover.

To provide adequate protection against solar radiation with a minimal thickness of snow it is imperative that the snow be of a uniform density not much less than 0.45 g/cm^3 and be everywhere in intimate contact with the ice surface. This requires that the snow be processed; usually compaction with rollers is suitable to accomplish both goals. Compacting in thin lifts (<10 cm) is best if possible. The temperature of the snow will also dictate the degree to which compaction can be accomplished. As temperatures warm, heavier loads and higher contact pressures can be placed on the snow resulting in incrementally bringing the snow density up to the desired level.

Ideally the protective snow cover over the glacial ice should consist entirely of fresh, clean snow. This may not be possible at some sites. The most common foreign material incorporated in the available snow will probably be mineral matter and pieces of ice. Neither is desirable in large concentrations, but mineral content can be very problematic. Almost any foreign material content will have the effect of increasing the snow cover's sensitivity to heating up.

If snow with a significant concentration of foreign material must be used, it is best if the contaminant is well mixed (distributed) with the snow. This minimizes everywhere the local concentration. Frequent processing will also be required to assist in keeping the surface layers as cool as possible. Planes and drags will accomplish mixing to a degree; however, typical agricultural tools like harrows or disks may perform this task better.

The rate of snow loss during the warm period will be accelerated by the presence of foreign material. Thus, a greater thickness of protective snow cover should be in place at the beginning of the warm period than would be required when using clean snow. Roughly, we estimate that the thickness of snow should increase by the same percentage as the concentration of contaminant in the snow.

Snow surface characteristics

The vital feature of the protective snow cover is its surface. Adequately protecting the glacial

ice surface from melt features is possible with a less than ideal thickness and composition of snow as long as the snow surface is properly maintained. If kept "fresh" the snow surface can provide a tremendous degree of protection from radiation damage. In scientific terms, the goal is to maintain a high albedo surface (high reflectivity).

At sites where solar degradation is prevalent, it may be wise to monitor albedo using radiometer measurements. Radiometers are manufactured in a variety of configurations and wavelength ranges. We recommend the type with hemispherical globes and the capability to measure total radiative flux, both short wavelengths (0.3–5 m) and long wavelengths (4–100 m). Radiometer readings should be made with the globe facing directly up and directly down, at a height of about 1 m from the surface. No shadows should be within a 45° cone emanating from the circumference of the radiometer. Readings taken when pointed upward provide a measure of the incoming radiation, and the downward reading indicates how much radiation is being reflected and emitted from the surface. The magnitude of the values read is not as important as the ratio of the two values. As a percentage, it is important for the protective snow cover to provide as high a reflection ratio as possible, but at least 60% is easily attainable. To facilitate taking radiometer readings at a number of representative areas around and on the runway, we installed a pair of radiometers on a stand (Fig. 24). We placed this tripod at various points of interest, allowed it to stabilize for 5 minutes, took a reading, and then moved on to another location.

The key features of the snow surface are its microroughness and permeability. If the snow surface is kept roughened, incoming radiation will be scattered to a large degree. This will reduce the amount of longwave energy that is transmitted into the snow and ice. If the processed protective snow surface is not maintained, it will develop a sheen or a glazed appearance resulting in a reflectance ratio of less than 50%. This crusty surface will impede air flow (permeability) through the snow cover. Thus, it will encourage heat build up in the snow. In addition, the iced surface will trap emitted radiation that is attempting to escape from the earth, reflecting it back into the snow cover and increasing the heating potential. When this happens, the snow cover thickness will not appear to diminish, but the snow beneath the surface will deteriorate rapidly and eventually the

surface will collapse. In areas where this happens, it is generally too late to avoid heat buildup in the ice. Recovering the areas with fresh snow is the only option at this point, and even that may not be enough to prohibit a 3° to 5°C jump in ice temperature.

We found that snow planes and drags do a good job of keeping the surface roughened and permeable. These devices essentially stir the very top of the surface and leave it with a reflectance ratio of as much as 85%. This surface processing will slightly increase the rate of loss of snow cover due to ablation, but this loss rate is much less, and is more manageable than, the rate of loss due to subsurface melting in the snow that can occur if the surface is not treated. During the peak of solar intensity and air temperature, the Pegasus runway snow surface needed treatment at least every other day, sometimes daily. Also at this time in the season, grooming works best late in the coolest part of the day (generally after midnight and before 5:00 a.m.). Snow loss is minimized by working the surface when the sun angle is low and the air temperature has already reached its daily minimum. In addition to minimizing snow loss by working at this time of day, damage to the surface caused by the towing machinery will also be limited.

Snowfall during the peak temperature/solar intensity period can occur at some sites. These snows are often made up of large flakes that fall gently onto the surface. Such snow has a very high reflectance ratio and can provide a great boost in protection of the ice runway. This may be an advantage or disadvantage, depending on the amount of snow needed and the amount present on the runway. During the 1992–93 summer, a light, fluffy snow fell during very calm weather at the Pegasus site approximately once per week. This slowed the ablation process and the net loss of material from the runway's protective cover was almost nil. Without great confidence in the ability to predict snowfall during this period at a given runway site, we do not rely on summer snowfalls when planning for the protection of the runway.

The goal of maintenance activities should be to provide a highly reflective and permeable surface during the critical period when air temperature and solar intensity are at their peak. Surface maintenance procedures should be governed by 1) reflectance ratio readings on the runway, 2) net thickness of protective snow cover, 3) position within critical warm period cycle, 4) temperature profile within the runway ice, 5) expected dura-

tion and intensity of solar/air-temperature peak, and 6) probability of snowfall based on historical data. Frequent dragging and planning of the runway snow cover will ensure a highly reflective surface but will speed evaporative losses. This can be used to advantage to protect the ice from melt feature development, while at the same time minimizing the amount of snow to be removed mechanically once the critical period has passed. If it appears that the snow cover present on the runway is only marginally enough to provide the protection required, one should settle for snow surface grooming every second or third day, with the resulting gradual drop in reflectance during these few days. This latter sequence will limit snow loss while maintaining a minimal degree of reflectance. In either case, constant attention to the runway is required by experienced runway maintenance personnel. Data on how temperatures are fluctuating during the day and cumulative seasonal ice and air temperature, incoming radiation levels, and snow cover density, thickness, and composition must be compared each day to make informed decisions about maintenance activities.

Removal of protective snow cover

The protective snow cover may be removed as soon as conditions allowing the formation of melt features have passed. The determination of this point in time was discussed at the beginning of this section. Our experience has been that almost no snow loss occurs on a maintained cover. If not maintained, snow loss through ablation and melting will be concentrated in various locations and will accelerate rapidly out of control.

If more than 15 cm of snow needs to be removed from the runway, a two-stage process should be used. In this case, the first layer removed should be about 10 cm and stripping should start from the outside edges of the runway and work toward the centerline. At Pegasus we used the grader to peel off and windrow the top layer of snow by extending the skids at either end of the grader blade so that they could penetrate the protective snow cover and follow the ice surface (Fig. 80). The snowblower was capable of operating on the freshly graded snow surface to remove the windrow snow to the sides of the runway.

The second stage of stripping, or the only stage necessary if less than 15 cm of snow were present, will remove all but 4–5 cm of snow from the ice surface. This stripping should proceed from the centerline outward toward the edges of the run-

way to leave a clean operating surface for aircraft. The 4–5 cm of snow is left as a wearing surface and to provide a soft surface for the aircraft tires to pass along, as mentioned earlier.

Other mechanical means could perhaps be used to remove the protective snow cover. However, we doubt that any could be more efficient than the grader–snowblower combination. Natural methods, such as taking advantage of strong winds of a favorable direction, may not occur at the right time and are probably unreliable at most sites.

Using the snowblower, we add the stripped snow to the natural snow along the sides of the runway. This will have the effect of placing the runway in a depression, which is not generally desirable since the potential for snow drifting on the runway is greatly increased. Consequently, following opening of the runway (stripoff and beginning flights), these flanking snow berms will require attention. The most important detail is to shape the berms so that they minimize the potential for slowing the wind stream enough to allow airborne snow to drop out. This is accomplished by ensuring a smooth surface on the berms (i.e., no scarps) and keeping the slopes of both sides of both snow berms at or below 14%. Using the means discussed in the section on snow management, these berms should ultimately be reduced or removed entirely. Ideally, except for the runway surface itself, the site should be brought back to the surface topography present before any construction began. This will probably require maintenance crews to work on reducing a given year's snow berms during the following season's cold period, when snow strength is great enough to support heavy equipment. Snow berms along the flanks of the runway can become a serious problem, since each year another layer of protective snow cover will be removed from the runway and placed along the sides.

At the Pegasus site, construction activities during the experimental phase generated large berms along both sides of the runway. Each time the runway snow cover is removed, snow is added to these berms. We are currently studying means of removing the snow berms using natural means. During the 1994–1995 austral summer season, we will establish test plots to try out several schemes of slightly accelerating snow loss in a controlled manner using the wind, warm air temperature, peak solar radiation, and combinations of these as driving forces (Lang and Blaisdell 1997).

MONITORING AND DATA ACQUISITION

All measurements made during the process of siting, construction, and maintenance of a glacial ice runway should be entered into some form of computer database. Long-term operation, maintenance, and reliability of the facility will rely heavily on knowledge of the site and its unique characteristics. It is unwise to rely solely on individual's personal experience and knowledge to manage the runway. An ideal database would be PC-based and would be divided into several sections. It should have the capacity for entering general information (such as observations of environmental patterns and operational techniques), input of infrequent measurements, and output from automated data gathering systems (such as AWS information or thermocouple readings). Software should be available for user-driven printing and plotting of synoptic data and for displaying short-term and long-term trends. Any information that could be of use in making decisions about the maintenance and operation of the facility should be conveniently stored in the database and regularly updated and accessed by facility managers.

CHAPTER 6. OPERATIONS

At the time of this writing, we have four seasons of typical operational experience with the Pegasus runway (see App. E for “as-built” drawings). Operational issues are obviously dependent on the type of aircraft used, the flight season employed, and the location and life expectancy of the glacial ice runway. This chapter is strongly influenced by the specific case of the Pegasus runway. We suppose that this will still yield a good general picture of the important factors to be considered. Additionally, we expect that operational patterns and methodology at any new runway will evolve over time and that a regularly updated manual detailing the standard operating procedures (SOP) will be present at, and unique to, each runway.

Except for aircraft, all traffic on the glacial ice runway should be restricted to only that which is absolutely necessary. As much as possible, traffic should utilize access routes along the flanks of the runway. When it is necessary to drive on the runway, we strongly encourage the use of wheeled vehicles only. Further, they should be clean (free from dirt, dust, ice chunks, and fuel and lubricant drips).

PERSONNEL

The *site manager* would most likely also act as the focal point for the runway during air operations. The site manager will be responsible for meeting regularly with flight schedulers, flight crews, and program managers. The site manager would function much as an airport manager at a moderate-sized rural runway in the temperate world.

Some programs (e.g., USAP) operate year-round, with essentially different work forces for the summer and winter seasons. In such a situation, a *winter manager* should also be assigned to the runway. This position could require minimal effort if the runway were unused during the winter, but, if winter flights are scheduled, the position will require all of the responsibilities and concerns of the summer manager. Of course, winter operations will entail some different issues.

A *facilities manager* will also be required. If the air traffic load is low, the site and facilities manager positions could be filled by one individual. The primary role of the facilities manager is to maintain the “airport.” This would include man-

agement of the support buildings, fuel tanks, heavy equipment, generators, water and food, waste, and markers and signs.

A glacial ice runway facility with an air traffic load similar to that at the Pegasus runway (currently 50–60 flights per month during the operational period) will require a dedicated *fuels manager* during the operational season. This position will require matching bulk fuel delivery (overland, by ship, or by tanker aircraft) to fuel needs (based on air traffic volume). A major part of the fuels manager’s job will involve fueling aircraft. This requires specialized training for each aircraft type expected at the runway. The fuels manager will also be responsible for ensuring that spill potential is within acceptable limits and that a spill response strategy and cleanup equipment are in place.

It is critical to have on site a *crash/fire crew* and equipment any time air operations are possible. The size and specific skills of the crash/fire crew will be dictated by the type of aircraft used, flight frequencies, and the specific requirements of the air support contractor. Specialized training will be required of each crew member. A crash/fire chief, with significant experience and training, should be assigned. This individual should report directly to, and coordinate closely with, the site manager. Procedures for crash/fire response should be established well in advance of the operational phase. These procedures must be developed jointly with flight managers so that any specific requirements of the contractors providing flight services are met. At Pegasus, currently the military (U.S. Navy and U.S. Air Force) provide aircraft and flight crews and thus U.S. military crash/fire guidelines have to be met by the USAP civilian contractor crash/fire crew.

A *meteorologist* or *weather observer* will be required to cover the runway and provide the pilots and flight planners with up-to-date information that could affect flights. This individual may provide weather information and forecasting for other operational elements within the program as well (e.g., other local runways, such as the sea ice runway at McMurdo; balloon launchings). The weather observer will also need to coordinate closely with flight managers and air crews to ensure that they receive the information required to make flight plans and to calculate payloads and fuel needs.

Air traffic and ground controllers are recommended at any runway. If there are infrequent flights to the glacial ice runway, and no other aircraft activities in the area (e.g., from other runways or helicopter use), it may be possible to dispense with an air traffic controller and have the facility manager act as a ground controller. Obviously, the air traffic controller will need to coordinate with flight managers, air crews, and the runway maintenance staff.

Equipment operators and a *mechanic* will also be required on site to operate and maintain runway maintenance equipment, aircraft support machinery (auxiliary generator and heater), the power plant for any buildings and vehicle plug-ins, cargo and passenger handling equipment, and to assist in fuel delivery to the site. In rare cases, aircraft pusher vehicles may also be present.

It is recommended that all of the operational staff attend airport training courses offered through colleges and technical schools and, in the U.S., seminars conducted by the Federal Aviation Administration (FAA). In addition, regular (weekly in the case of the Pegasus runway) meetings are recommended among aircraft operations managers, runway managers, and support foreman to review flight schedules, maintenance needs, and safety and logistics concerns.

INFRASTRUCTURE

We strongly advocate having only minimal facilities present at a glacial runway site. We have assumed that sites such as Pegasus can tolerate only minimal perturbations in order to remain glaciologically stable and thus we have limited the facilities on site. Since the Pegasus runway is currently only operated for a limited time period, we have required that all facilities, including runway markers, be removed from the area when it is not in use. Although this requires some extra work in setting up and taking down, we feel that it is important to the long-term life of the runway that the site be left as close to its natural state as much as possible. All of the Pegasus facilities are sled mounted, making removal quite easy.

The most likely piece of infrastructure needed on site will be runway markers. Although most pilots and flight crews operating in polar regions have considerable “bush” experience, they may insist on runway markings if repeated flights with passengers and sensitive cargo will be the norm at the glacial ice runway. Markers along the edges

of the runway are most important (App. E). Often these markers indicate distance remaining. The markers are usually placed every 1000 ft on both side of the runway and display single digit numbers that indicate the multiple of 1000 ft remaining on the prepared runway in the direction of travel. Thus, the markers have different numbers on either side.

Distance remaining markers should be placed about 18 m (60 ft) off the edge of the runway and be as tall as possible but still be capable of passing under the wing of any aircraft likely to use the runway. At Pegasus, we used 1.2- × 1.2-m (4- × 4-ft) plywood panels nailed to the ends of 3.6-m- (12-ft-) long × 10-cm- (4-in.-) thick square wooden posts (App. E). The ends of the support posts are placed in drilled holes in the ice. The top of the markers are about 2.4 m (8 ft) above the ice surface. The panels are painted flat black; an international orange numeral, 1 m (3.5 ft) tall, is painted onto this background.

Additional markers were required during some of the initial flights to Pegasus until the air crews became familiar with the runway (App. E). When a new crew or a new aircraft type will fly to the runway, it may be prudent to increase markings to assist in familiarization. Weather conditions may also affect runway marking. If poor contrast, blowing snow, or anything that limits visibility is common at the sight, lead-in markers should be used. These markers may also contain metallic components (foil wrapped on posts, or commercial targets) so that aircraft equipped with radar can be led to the runway. In most cases, it will still be necessary for pilots to land using visual navigation. Standard patterns for runway markings exist. The full complement of markers used at commercial airports will probably be unnecessary at a glacial ice runway. In fact, as noted above, we encourage that markers be minimized to reduce the chance for snowdrift accumulation (Pegasus has this problem) or localized ablation. Discussions with air operations managers, the flight crew representative, and the individual(s) responsible for safety should establish necessary runway markings.

All facilities at the runway must be situated in accordance with some form of “exclusion zone” guidelines. The exclusion zone is defined by an imaginary three-dimensional surface surrounding the runway. This zone differs for various aircraft and for the sides and ends of the runway. Its purpose is to remove obstacles from the normal path of incoming and outgoing aircraft. At Pe-

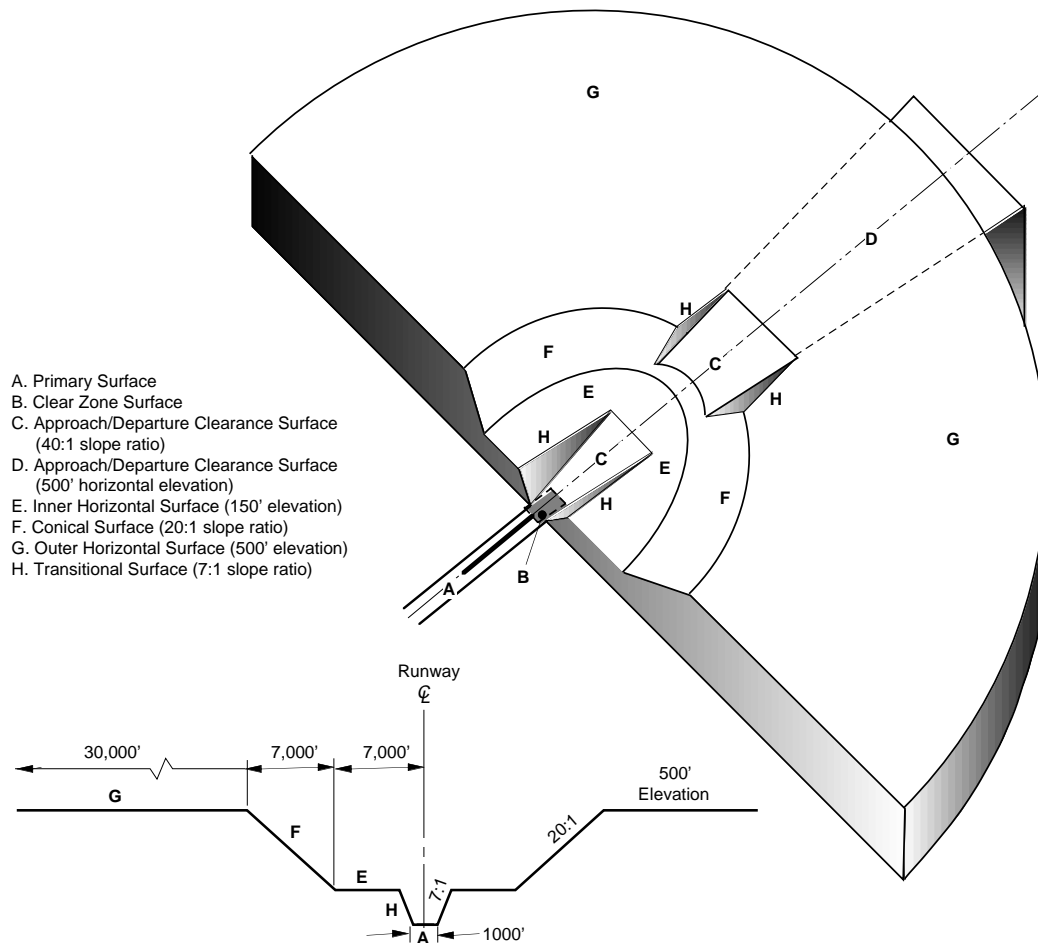

Figure 81. Exclusion zone maintained on the Pegasus runway during air operations.

gasus, we used the guidelines given for U.S. Navy and Marine Corps facilities (Fig. 81; Department of Navy 1982).

The Pegasus site is approximately 15 km (9 mi) from Williams Field and 28 km (17 mi) from McMurdo during the flight operations time of year (Fig. 2). Thus, it is necessary to have a degree of self-sufficiency on-site. During flight operations, we have the following facilities available at Pegasus: generator shed, maintenance personnel hut with cooking supplies and food, tool and parts shed, multiperson latrine, passenger terminal, and a 75,000-L (20,000-gal.) fuel tank. All of these facilities are sled mounted. All except the maintenance hut and tool/parts shed are moved to the site one week prior to the first flight and removed immediately when operations cease. These facilities are located, relative to the runway, as shown in Figure 82 and Appendix E. Note that, except for the fuel tank, all facilities are on the access road side of the runway. This minimizes the potential for vehicle and aircraft interaction.

The passenger terminal is a large (about 6×12 m; 20×40 ft), heated modular building mounted on skis (Fig. 83). Because as many as 1000 passengers per season leave from the Pegasus runway in groups up to 60, this facility has comfortable airport-terminal-style seats and reading materials for passenger convenience. Every attempt is made to coordinate passenger arrival at the site with aircraft arrival so that waiting is minimized (our target was a 15-minute wait, just long enough for the pre-flight briefing). However, timing is not always exact, and the time required for cargo operations and fueling can vary. Potable water is shuttled to the passenger terminal building from Williams Field daily when flights are operating. A food supply for maintenance workers is present on site and could be used in an emergency for passengers and air crews. The passenger terminal is equipped with a telephone to allow the crash/fire crew, meteorologist, and passenger transport escorts to communicate with McMurdo and Williams Field.

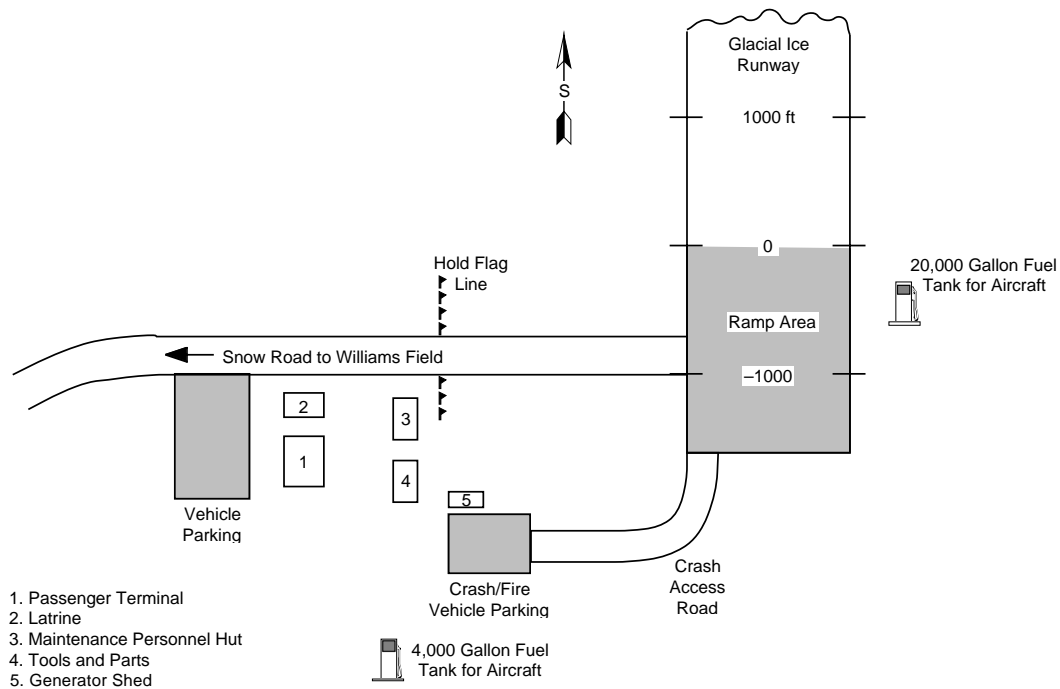

Figure 82. General location of support facilities at Pegasus during air operations.



Figure 83. Passenger terminal used during air operations at the Pegasus runway (shown in position at the annual sea ice runway).

The crash/fire crew and medical personnel usually arrive on-site shortly before the aircraft arrives and leave about an hour after the plane departs. These individuals generally sit in their vehicles throughout the flight evolution. However, they occasionally visit the passenger terminal and the maintenance hut.

An on-site 30-kW diesel generator provides electrical power to the buildings. Only a small amount of power is consumed by the buildings at this time of year, primarily for heat. The generator also provides power for the various heaters installed on maintenance equipment and the crash/fire vehicles. When not in use, these

vehicles are plugged in to keep their fluids, including fire-fighting liquids, warm. The generator has its own 1800-L (500-gal.) fuel tank.

The primary fuel tank on-site at Pegasus is a 75,000-L (20,000-gal.) steel vessel mounted above a containment tray. The tank is towed empty to the site shortly before the beginning of flight operations and it is supplied with JP-8 (the single fuel used in McMurdo for everything except a few gasoline-powered engines) from 19,000-L (5000-gal.) sled-mounted tankers pulled by tractor from Williams Field. A pipeline connects Williams Field with the large fuel storage tanks on Ross Island. A portable filter, pump, and hose system are used to transfer fuel from the 75,000-L (20,000-gal.) tank to aircraft. A backup pump and hose system is recommended in the event of a malfunction during aircraft fueling to avoid delays since the Pegasus site is so remote. The tank is situated about 45 m (150 ft) off the edge of the ramp area and is about 150 m (500 ft) to the north of the runway threshold. Although having the tank located a greater distance from the runway would be ideal, the current physical arrangement of the ramp and runway area (Fig. 82) does not allow it to be farther away.

A separate sled-mounted tank (approximately 15,000-L or 4000-gal. capacity) is on-site to supply maintenance equipment with fuel. It is refilled as necessary by traveling back to Williams Field. This tank is brought to the site when maintenance operations begin early in the season (September) and remains until all of the facilities are removed at the end of the flight operations window. To avoid having to pump fuel, this tank is parked on a snow berm about 3 m (10 ft) above the natural snow surface, thus allowing for gravity feed. The berm is built up with a bulldozer early in the season and is situated some 50 m (160 ft) north of the buildings on-site to avoid drift problems. A pathway to the tank is kept clear with on site maintenance equipment (snowblower, grader, and drags).

In some circumstances, a building for warm storage and staging of cargo may be necessary. Currently, this is not required at Pegasus, since cargo labeled “do not freeze” is usually loaded on LC-130s at Williams Field. The aircraft then hop over to Pegasus to take on passengers or fuel and take off on wheels. If necessary, such a storage building would require a large overhead door to facilitate forklifts and loaders to maneuver palletized loads. The building should ideally be

ski mounted so that it minimizes snow drift problems and can be removed from the site when not needed. Likewise, it should be situated on site so as to not interfere with other logistics operations, minimize snowdrifts, be well out of the exclusion zone, and be accessible for cargo handling equipment. Should such a facility be needed at Pegasus, we recommend that it be situated immediately north of the crash/fire vehicle parking area (Fig. 82).

In the event that facilities need to be permanently left in the vicinity of a glacial ice runway, they should be moved or sited so as to minimize snow drifting or ablation problems. Ideally, they could be placed on top of a “winter berm” as is done with many mobile pieces at Williams Field. Such a berm could be built up by bulldozer in the accumulation zone a short distance from the runway to avoid any possible drift impingement on the runway, ramp, and usual facilities sites. The berm should probably be aligned east-west, perpendicular to the storm winds, and be about 1.5 m above the surrounding snow surface. The length and width would be dictated by the number and size of facilities and equipment parked there for the off-season. The closest position would be to the east and north of the runway. Although this increases the risk of losing these facilities and equipment should the ice shelf calve, this risk is probably not much different than it would be for storing them at Williams Field, which is currently about the same distance from the ice edge but in an area of the ice shelf that is moving considerably faster.

EMERGENCY PROVISIONS

At sites that are remote from the main camp, such as the Pegasus runway, it is advisable to have emergency provisions in place. This should include survival training of the on-site personnel (runway manager and maintenance crew) as well as those who will frequent the site (cargo and passenger handlers, crash/fire crews, weather observers, etc.). As a minimum, food, water (or snow-melting supplies), and sleeping bags should be present for several days for close to the maximum number of persons expected to be at the site at any time. In addition, first-aid kits and hand-held radios should be available in an emergency. Obviously, the more remote the site, the greater the quantity of supplies to be cached.

WEATHER OBSERVATIONS

The weather present at the glacial ice runway site during the period of air operations will dictate the quality and quantity of weather data required. Requirements will also be driven by the nature of the aircraft used (on-board navigation aids), availability of nearby alternate landing sites, flight origination point, and the standard operating procedures of the pilots and air crews. Many of the flights to Pegasus originate in New Zealand in (L)C-130 aircraft. The fuel capacity of the aircraft is such that the point of safe return (PSR), or point at which a decision as to whether to turn back or continue based on fuel remaining, is approximately 1–2 hours short of the runway. Therefore, flight managers and ground personnel should have available adequate weather information to make accurate forecasts for several hours to assist the incoming flight crew in making this decision. To avoid wasted flight time, adequate weather forecasts are required for the time period extending from pre-launch to estimated time of arrival. Fortunately, McMurdo has a sophisticated weather center, using data from satellite imagery and numerous automatic weather stations around the continent, which makes forecasting possible. Based on the forecasts, decisions are made whether to launch flights from New Zealand, thus minimizing “boomerang” flights.

Localized variations in weather should be noted over time by an on-site weather observer as a function of specific occurrences. For example, during the austral spring and autumn it is common for the Pegasus site to have adequate visibility for air operations when virtual white-out conditions are present at Williams Field. At other times, there can be a very strong southerly wind with active snow movement at ground level at the Pegasus runway while Williams Field has calm conditions. The combination of large scale weather data (e.g., from McMurdo Center) and a good understanding of local variations will provide the necessary information for flight planning and decision making at critical times.

AIR AND GROUND CONTROL

At the Pegasus runway we used the tower at nearby Williams Field for air traffic control. This ensures traffic coordination between the Williams

Field skiway and Pegasus, which operate concurrently during January and February. At times, there have been seven flights per day operating from Pegasus and, occasionally, there is a plane on the runway while another plane circles overhead awaiting its departure. The Pegasus runway has never had two aircraft on deck at the same time, but there is ample room on the runway and “ramp” area to accommodate two aircraft. We recommend that Pegasus have its own air traffic controller if two planes will be on the runway at once or if concentrations of flights become a regular occurrence.

Ground control is a critical issue. Once the Pegasus runway became operational, we found that it was difficult to immediately make the transition from viewing the site as a construction zone to a restricted area. Personnel briefings and written guidelines for anyone preparing to work out of a camp using a glacial ice runway should include a clear indication of the restricted area around the runway and explain proper procedures for approaching the runway.

At Pegasus, a single access road leading to one end of the runway makes it relatively easy to control access. A single ground controller is required, having radio contact with anyone who will have business on or in the immediate vicinity of the runway when aircraft are in the area. The ground controller must also be in constant contact with, and be the only person on the ground communicating with, the air traffic controller. Guidelines for both the ground controller and for persons needing access to the runway can be found in a document published by the Federal Aviation Administration (1990). Such guidelines can be obtained and customized as necessary for each specific glacial ice runway by the runway manager and assigned ground controller. At Pegasus, the crash/fire chief often acts as the ground controller.

Ground control will obviously include coordination of vehicles and persons on the runway and approaching aircraft. Since it will not be reasonable to establish physical security around a glacial ice runway to limit access, the ground controller will also need to inspect for foreign objects (e.g., people, seals, penguins, bears, or debris) on the runway immediately prior to landings and takeoffs. This can be achieved rapidly using a snowmobile, a rubber-tired all-terrain vehicle (ATV) or a pickup truck for transportation.

PAYLOAD

When aircraft arrive at the runway, our practice is to have them taxi northward on the east side of the runway, enter the ramp area, and make a 180° turn at about the -1100-ft mark. The aircraft then taxi southward along the west side of the ramp area and park adjacent to the fuel tank (starboard wing tip approximately even with the west edge of the ramp; Fig. 82). Our aircraft, the C-130, LC-130, and C-141, have fuel ports along the starboard side just aft of the main landing gear. After completion of fueling and passenger and cargo shifts, performed at this parking spot, the aircraft taxi to the center of the runway at the 0-ft threshold in preparation for takeoff.

Operations at the Pegasus runway generally involve fueling, loading, and unloading of cargo and passengers. Only after the fuel and cargo have been secured are passengers allowed onto the ramp area. When scheduling is perfect, the passengers arrive in busses from McMurdo and Williams Field just as fueling and cargo loading have been completed. Otherwise, the passengers wait in the Pegasus terminal building. When the aircraft is ready, the busses used to transport personnel from McMurdo to the Pegasus site to take passengers onto the ramp and park about 30 m (100 ft) off the aircraft's port side slightly ahead of the nose. Passengers, and their hand-carry bags, approach and enter the aircraft from the forward crew door on the port side in groups of four.

Cargo loading procedures are a function of the payload, its packaging, the aircraft type, and the standard operating procedures of the air crew. All of the aircraft visiting the Pegasus runway accept large cargo through a rear ramp and door arrangement. The USAP principally uses standard U.S. Air Force aircraft pallets to shift cargo. Loads may be secured to the pallet by netting, banding, or wood frames. We utilize rubber-tire loaders such as the Caterpillar 950 and IT-28 models (Fig. 20) to move the pallets, one at a time, into and out of the aircraft. This is typically an inefficient procedure, since the fine control and visibility desired when working close to aircraft are not present on such construction vehicles. However, using ground guides and aircraft platform spotters, the job is accomplished routinely without incident. Consideration is being given to constructing a minimally adjustable rigid sled that could hold up to five pallets in a line. Maneuvering this sled into position behind the aircraft with a pusher

vehicle may still be tricky, but once in place, it would be efficient to shift multiple pallets onto or out from the aircraft.

We strongly encourage the use of rubber-tired vehicles for cargo and passenger movement while on the runway. In some cases this may require that the vehicle is brought to the site on a sled. The disadvantage of tracked vehicles are their less refined directional controls (critical when aligning pallets with typical aircraft deck rail systems), their aggressive grousers that cause damage to the ice, their rough ride (potential damage to sensitive cargo), and the greater amount of contaminants generally associated with their operation (lubricant drips and dirt, ice, and soiled snow deposits).

A "hold line" (flag line) has been established on the snow road about 180 m (600 ft) short of the ramp area preceding the runway threshold (Fig. 82). When aircraft using Pegasus are in the vicinity, access beyond this line requires ground control permission. The ground controller usually assumes a position somewhere between the hold line and the edge of the ramp area. Passenger and cargo transporters coordinate with the ground controller to access the ramp and aircraft.

AIRCRAFT PARKING

We operate the Pegasus runway as a "turn-around flight" facility; aircraft at Pegasus are rarely on-deck longer than 2 hours, often it is less than one hour. This limits contamination from aircraft and support equipment. Aircraft using the runway originate from New Zealand (principally passenger flights) and from Williams Field (principally cargo flights to South Pole).

Effective use of aircraft resources at some sites will require parking. When this is required, we advocate that aircraft be parked well off the runway in a segment of the ramp that can be abandoned at some future time if it becomes overly contaminated, without impact to the runway itself. A thin snow cover in the area of parking will assist in cleanup of aircraft fluid drips, soot associated with engine start-up and warm-up, and preservation of the ice.

Should parking be required for longer than a 24-hour period, some consideration should be given to localized warming of the ice due to the presence of the large metal mass and to pressure melting of the tires into the ice. Neither of these

factors is likely to be overly problematic at most sites that can sustain a glacial ice runway. In both cases, a good snow layer, perhaps 10 cm (4 in.) of compacted snow, will go a long way toward alleviating these concerns.

Inevitably, maintenance will eventually be required on an aircraft visiting a glacial ice runway. This work should also be performed in a location well off of the runway. It is likely that more contamination will occur than for an aircraft that is simply parked. It may be advantageous to add snow around the aircraft after it is parked to assist in cleanup and in protection of the underlying ice. If extended parking or maintenance is required at the Pegasus site, we recommend that a site be prepared immediately off the northeast end of the ramp area. (The site should be properly surveyed with core samples and perhaps proof rolled.)

At aircraft parking sites, wheel chocks should be used. Small aircraft may also require tie-downs in the form of “deadmen” frozen into the ice. Parking of small planes should be into the strong wind direction. Consideration should be given to a single “nose leash” if particularly strong winds are expected, allowing the aircraft to skid around somewhat to remain facing the wind, rather than suffering potentially damaging side forces.

PROOF ROLLING

Recertification of a glacial ice runway should not be routinely required. However, any number of conditions may make it wise to proof roll the runway again. The most notable situation would be when a new aircraft type is to visit the glacial ice runway. Analysis of the potential aircraft’s landing gear configuration and loads will suggest whether it represents a more severe test of runway strength than the usual aircraft using the runway. We recommend that the runway be proof rolled again if either the contact pressure, individual tire load, or gang tire load exceed by more than 10% the values used when originally proof rolling the ice. The proof cart loads for the new aircraft should be calculated using the original factor of safety (1.25) and the tire size and configuration may need to be adjusted.

If the runway site experiences an unusual temperature regime in a given season or throughout a year, we encourage that the runway be proof rolled prior to resumption of flights. In regions

where the glacier is moving fast, annual proof rolling is prudent to ensure that subsurface stress response has not created any flaws or weaknesses that will affect runway strength.

WASTE AND POLLUTION MANAGEMENT

The importance of pollution management cannot be overstated. This is not entirely for altruistic reasons, although preservation of a glacial ice site purely for ethical reasons is worthy. A key element to maintaining a glacial ice runway and for long-term viability is keeping the site as close to natural as possible.

It is easy to establish and enforce a waste management plan. This plan should cover collection and disposal of common wastes produced at the site, such as food containers, paper, and human wastes. Many polar operators now remove all of these types of wastes, in appropriate containers, back to their home base for disposal at regulated facilities. In some cases, the camp served by the glacial ice runway will have its own disposal and treatment equipment for common wastes. If necessary, the runway site will need to develop its own facilities for handling wastes. This may include processing equipment, incinerators, and balers. Of course, the simplest and most effective form of waste management at the site will be to take every effort to reduce the quantity and types of waste that are brought to and generated at the site.

It will be much more difficult to control or cleanup of spills of fuel, oil leaks from aircraft and support equipment, and soot from engines. Nevertheless, it is critical that tools and techniques for dealing with such pollutants be in place. Any spill or contaminate should be cleaned up as much as possible as soon as possible. The Pegasus site is inspected by the maintenance foreman on a daily basis and any foreign objects are removed. The foreman also acts as an enforcer for the waste and pollution policies including reprimands for violators (e.g., no more coffee allowed for individuals who toss the contents in the bottom of their coffee cup out the door). Every effort should also be made to clean up after aircraft, including the soot and surface melt puddles formed when they are parked with engines running. In the event of a major problem (e.g., large fuel spill, aircraft fire) it will be necessary to access specialized person-

nel and equipment to clean up. Such an event may lead to the loss of the runway, or a portion thereof, but cleanup should still be completed. Every effort should be made to return the site to its original condition.

Aside from the usual drips of fuel, hydraulic fluid, and other fluids, the most serious contaminate is soot from engine exhaust. This will accumulate and coat the runway surface particularly in parking areas (load/unload and fuel areas), at the threshold where runup and takeoff start, and in the region where the wheels leave the ground. The soot will build up to a large concentration over the span of seasonal operations and will probably persist into following years. In these areas, it is advisable to keep a thin layer of expendable snow (2–5 cm). As soon as soot is present on the surface, it should be dragged or planed to mix the soot into the snowpack and remove it from the surface. After some time, replacing this protective cover with fresh snow will be necessary.

Parking areas will collect the most soot if engines are kept running during load/unload and fueling operations. We found that we could minimize soot accumulation by explaining this problem to the flight crews and requesting that they shut off engines as soon as possible. In most cases they were very accommodating and often shut down all but one engine soon after touch down and turned it off when parked. When conditions are particularly cold at a site, shutting down engines may not be wise. Flight crews can advise runway operators in this matter and, when it is cold, soot accumulation is not as much of an immediate problem.

Parked aircraft often leave an iced contact patch at each tire station. This is the combined result of pressure melting and heat transfer from the aircraft to the ice. In addition, running engines and engine heaters created large iced patches. These iced spots have a sheen and should be roughed-up or covered with a thin layer of snow as soon as possible to avoid their acting as a solar radiation trap.

Vehicles other than aircraft may also leave iced tire prints when parked. Thus it is a good idea to avoid parking anything on the runway. In addition, nearly any object (e.g., vehicle, building, implement, fuel hose) that is stationary on the runway will act as a heat source due to absorbed radiation and is best kept off the runway except when performing necessary tasks. Such stationary objects should be removed as soon as possible and the area dragged or planed to freshen the surface and remove any iced-over spots. Periodically, it may be necessary to perform “touch up” grading at sites, such as where fueling is done in order to remove surface melt features that have become permanent in the runway or ramp area surface. If a very large area is to be regraded, the as-built blue prints will need to be consulted and the laser control used to maintain proper control over surface smoothness and final grade.

SCHEDULING

The following is a list of approximate dates for aspects of operations at the Pegasus site. We caution that some of these dates are governed by the results of measurements, not by the calendar. Such dates are listed in *italic type*.

Flight operating window after the peak temperature.	
All buildings, fuel tankers in place	7–14 January
<i>Stripping the protective snow cap</i>	<i>10–16 January</i>
Simultaneous proof rolling/patching, if required	10–16 January
Runway markers in place	15 January
Radar reflectors in place, road dual flagged for shuttles	10–16 January
Begin flight operations	16–25 January
Flight operating window just prior to the peak temperature. Currently this would only occur in an emergency situation if the sea ice runway were unavailable.	
All buildings, fuel tankers in place	15 September
Stripping the winter snow accumulation	15–25 September
Proof rolling/patching	20–30 September
Runway markers in place	25 September
Radar reflectors in place, road dual flagged for shuttles	28 September
Begin flight operations	1 October
Last day of flight operations	31 October
Begin covering runway with protective snow cap	1 November

CHAPTER 7. FUTURE CONSIDERATIONS

LIMITS TO LIFE EXPECTANCY

No runway is expected to last forever, even in the temperate world. Natural processes are constantly working to erode any runway and its support facilities. Although maintenance activities are performed largely to counter these forces, several threats may be insurmountable in the case of a glacial ice runway. In addition to melt pool formation, which has been discussed earlier and in Lang and Blaisdell (1995), the following issues could be of concern.

Glacier movement

The most obvious limit to the long-term viability of a glacial ice runway is movement of the glacier on which the runway is sited. In some cases, glacial movement can be very significant, whereas in others the movement is so slow as to be a non-issue. During data gathering in the initial phases of siting such runway, the speed and direction of glacier movement will have been determined.

Glacial movement could carry a runway into a region of ablation and melting, or into an accumulation zone. Either case would probably result in an ever increasing amount of maintenance required to operate the runway. At some point it would be too expensive or time consuming, and the runway would need to be abandoned. Movement could also push the runway into an area where crevassing and cracking were prevalent, perhaps where the glacier travels over a bedrock bump, or where it expands upon exiting a neck. Yet another threat from movement could be the proximity to nearby topographic high points. This could eventually impinge on the normal and acceptable glide slope of aircraft landings and takeoffs. By then the runway will likely need to be relocated for other reasons.

At the Pegasus site, none of the above threats are of concern. The site is near the ice shelf edge, and it is certain that the shelf will eventually calve and take all or part of the runway out to sea. Although the rate of shelf movement toward the north and the change in elevation is known, it is not possible to estimate when a calving event could affect the Pegasus runway. Periodic extension of this runway to the south (by perhaps 150–300 m, or 500–1000 ft) would act to counter natural glacial movement northward, but would prob-

ably not significantly reduce the risk associated with calving.

Concentration of contaminants

Contaminants are an unavoidable part of operating an airport. Both aircraft and maintenance vehicles will introduce fuel, lubricants, and coolants to the area. Generally, these are in small, dispersed quantities, but in parking areas they may accumulate to the point where they can act as a significant magnet for solar warm-up. These types of contaminants tend to migrate downward leaving a rotted, weak surface and creating subsurface cavities.

The soot produced by aircraft when operating on the runway is especially insidious. Mineral particles can also be an especially troublesome contaminant. Over time, these deposits will accumulate to become layers that will increase the potential for surface melt at locations like the Pegasus site. Maintenance of a thin, removable snow “wearing surface” is about the only defense against soot buildup. Disposal of this contaminated snow must be to an area that can tolerate melting.

A plan to deliberately “migrate” the runway can lessen pressure on any given area. In this scheme, perhaps 150 m (500 ft) of runway can be added to one end and 150 m (500 ft) abandoned at the other at regular intervals (depending on amount of traffic and buildup of contaminants). At Pegasus, this scheme could be very attractive, with runway extension occurring southward (upstream relative to glacier movement) and abandonment of a segment of the northern end where operational activities are concentrated (fueling, landing, takeoff, parking, cargo, and passenger loading/unloading).

In an area where free water occurs during the peak of summer, water flowing on the surface may move toward the runway, since, after construction, it will likely present a local depression. Short- and long-term measures can be initiated to deflect water away from the runway. Infrequent occurrences of water on the runway, either from water flowing to the site, or from surface or subsurface melting, may not be devastating. While it may interrupt air operations, free water could be encouraged to freeze in place by saturating it with snow and ice or draining it away from the runway with shallow trenches.

Snowdrifting

Earlier we discussed the critical nature of snow control at some sites where a glacial ice runway might exist. In polar regions where snow is not completely lost during the summer, a small drift problem will nearly always eventually become a big problem if left unattended. Construction activities and topographic rearrangement will likely encourage drifting. If an effective plan for drift control is not determined and pursued the site may collect additional amounts of snow each season until it is inundated and unmanageable. Rarely will mechanical means be adequate to overcome a snowdrift problem in polar regions.

We originally thought that the Pegasus site would be very prone to snowdrift buildup with slight perturbations to the natural topography. Our experience over the past three austral summer seasons suggests that the site is not as sensitive to this problem as initially imagined. However, we do not yet have enough data to know precisely how much drift snow will be trapped in the long-term by the berms that were created during construction and the first several years of operation. The survey data in Appendix C are encouraging. We have taken care to ensure that any large snow piles have a gentle slope (1 in 7 or greater) in the lee and windward sides which appears to significantly reduce snow trapping. We are also studying natural methods to encourage selective accelerated snow loss. The berms created during construction have now become firm, making them more difficult to obliterate.

Climatic effects

A glacial ice runway site selected on the fringe of a glaciological zone, such as the Pegasus site, may be sensitive to slight perturbations in climatic conditions. For example, if a series of abnormally warm summers occur for one or more years, runway preservation efforts may become immense. It may not be possible to maintain runway ice integrity.

Anything that changes the solar intensity impinging on the site will also change the runway's heat balance. An increase in intensity, for example due to depleted ozone, may shift the boundary between chronic melt pool regions and protected ice areas.

Future of the Pegasus runway

Although the project that spawned the Pegasus glacial ice runway was a research program and the construction performed was experimental in

nature, the result was a usable runway. While we would do a few things differently if we were to start over today, the current Pegasus runway is robust and has the potential for a long life in its current form with proper attention paid to maintenance.

DEMONSTRATED UTILITY

We have shown the usefulness of the Pegasus runway for late season (mid-January to the end of February) use by LC-130s delivering cargo to South Pole Station (Fig. 65) and for redeployment of personnel to Christchurch using either C-130s (Fig. 84) or C-141s (Fig. 67). Continued reliance on the Pegasus runway for these uses alone justifies its maintenance. We can also cite many indirect advantages including reduced wear and tear on airframes, more efficient use of aircraft and flight crews, less wasted time by science and support personnel waiting for transport on outbound aircraft (Pegasus provides a reliable number of seats for each flight), enhanced morale (program participants now have confidence in their redeployment date), assurance of stocking South Pole before station close, increased efficiency for cargo handlers at South Pole, and timely station close-out despite late vessel arrival or storms.

From a quantitative standpoint, we can compare maximum takeoff weights and show that two flights from the Pegasus runway (wheels) are equal to three from Williams Field (skis). In 1993, 23 flights operated from Pegasus and more than 55 flights departed the runway in each year from 1994 to 1997. Thus, at least 122 flights were saved. If we assumed that half of these would have gone to the South Pole (6-hr round-trip) and half to Christchurch (16-hr round-trip), 1342 flight-hours were saved. An accepted cost for the Hercules (including fuel) is \$3,000 per hour, which results in a cost savings of more than \$4 million to the USAP. At the beginning of the 1996–97 and 1997–98 seasons, the Pegasus runway was used in late August for WINFLY (winter fly-in). This set-up operation is usually done using LC-130 aircraft, requiring a separate deployment from California. By using Air Force C-141 aircraft that are routinely passing through Christchurch, New Zealand, the USAP saved about \$500,000 on the cost of WINFLY each season.

These cost savings compare very favorably with the estimated cost of the runway, \$1.65 million over the five-year development, which included



Figure 84. Conventional C-130 during frequent routine operations from the Pegasus glacial ice runway.

capital equipment purchased specifically for this project (a grader and snowblower, which were critical to the runway construction, and other essential equipment such as the proof cart and several snow planes). This cost is also very attractive compared to the recently completed rock runway at Dumont D'Urville which cost more than U.S.\$ 25 million*, took 10 years and involved the leveling of several islands (Engler et al. 1990).

ENHANCED OPERATIONAL WINDOWS

The Pegasus runway provides the USAP with added aircraft operating windows. The runway allows wheeled C-130 operations essentially year-round. Other wheeled aircraft with higher tire pressures (e.g., C-141) could, in most years, access the runway from mid-January to near the end of October. Skied aircraft can use the runway throughout the year. Mechanical testing of ice strength and proof rolling of the runway at different times of the year when flight operations are desired will identify runway integrity for different temperature regimes.

Single vs. double operating window during austral summer

Logistically, it is much simpler and economical to use the Pegasus runway for only a single oper-

ational window each season. Since the sea ice runway is a well understood and inexpensive resource for the USAP and wheeled capability is not normally available to McMurdo in the late austral summer season, the logical choice is to operate Pegasus from about 15 January to 15 March. In an emergency, operating the runway could be possible for both the early season window (1 October to 25 October) and the usual late season time period. However, in addition to being expensive, there is some risk involved in being able to cover the ice with protective snow in time for the peak solar influx. We recommend that a double operations window not be considered except in dire emergencies.

Austral winter operations

Winter flights to the Pegasus site would require lights and possibly additional navigation aids. This is attainable and could offer tremendous new opportunities for polar night science that would otherwise involve complete automation or 6-month commitment for personnel. If winter flights are planned, we would recommend that they initially occur on a widely spaced regular schedule (e.g., one flight per month) to allow runway personnel to establish the procedures and techniques required for winter maintenance. Methods of using the wind to erode snow deposits on the runway will probably be needed in keeping the runway clear. Runway lighting should be provided with portable, self-contained (battery pack) type units to minimize size and impact

*A. Guichard, personal communication, 1995.

to the site. If an infrequent flight schedule is adopted, these units should only be emplaced for a few days prior to the flight and then retrieved after the aircraft is safely enroute to New Zealand.

The low temperatures at this time of year would make the snow road from McMurdo and Williams Field very sound with minimal grooming.

The ability to perform winter flights to McMurdo also provides increased safety for station personnel. Since alternative runways will not be available, we recommend that aircraft with an overhead point-of-safe-return (PSR) be used (e.g., C-141).

POTENTIAL FOR OTHER AIRCRAFT

Having shown that the Pegasus runway can support the C-141, we believe that virtually any aircraft could safely operate from this glacial ice. Certification for other aircraft will, of course, be necessary, with attention paid to the tire load and contact pressure, landing gear arrangement, and total and gang load. This opens the possibility for the USAP to increase utilization of New Zealand's or another Antarctic partner's aircraft resources. In addition, it may be beneficial to consider for the majority of the personnel transport needs passenger aircraft flown by a commercial contractor. Cargo aircraft could then focus entirely on moving goods and supplies.

SEARCH FOR ALTERNATIVE LANDING SITES

Each airport usually has an established list of nearby alternate landing sites in the event that the weather, air traffic, or an emergency make for problems in landing at the primary site. This is a prudent practice and is perhaps even more important in areas with inhospitable terrain for open field emergency landings.

The ability of the Pegasus runway to support wheeled aircraft at times of the year when McMurdo normally could only accept ski-equipped planes highlights the need to search for an alternative site within a few hours flying time of Pegasus. We recommend that a search be made for natural blue-ice sites in the Royal Society Range and along the Scott Coast that could serve as an emergency landing site. In the event that a

wheeled aircraft arrived in the McMurdo region and could not land at Pegasus or the seasonal sea ice runway, and had insufficient fuel to return to New Zealand, this ice area could be designated as an alternative landing site. This site should be reconnoitered and perhaps some emergency provisions (sleeping bags, food, tents) should be cached in the event they are needed. Possibly the rock runway at Dumont D'Urville could be used in an emergency as well. (This runway recently sustained storm damage and is considered non-operational by the French.)

LITERATURE CITED

- Abele, G.** (1990) Snow roads and runways. USA Cold Regions Research and Engineering Laboratory, Monograph 90-3.
- Arcone S.A., A.J. Delaney, and W. Tobiasson** (1994) Subsurface radar investigation at the Pegasus glacial-ice runway and Williams Field, McMurdo Station, Antarctica. USA Cold Regions Research and Engineering Laboratory, CRREL Report 94-12.
- Ashton, G.D.** (1984) Deterioration of floating ice covers. In *Proceedings of the 3rd International Offshore Mechanics and Arctic Engineering Symposium*, New Orleans, 12-17 February, Vol. 3, p. 29-33.
- Barthelemy, J.L.** (1992) Nomographs for operating wheeled aircraft on sea-ice runways: McMurdo Station, Antarctica. In *Proceedings of the Offshore Mechanics and Arctic Engineering Conference*, Calgary, Alberta, Canada, 7-12 June, *American Society of Mechanical Engineers*, IV: 27-33.
- Barthelemy, J.L., and C.E. Thomas** (1993) The NCEL sea-ice grader. *Military Engineer*, 85(558): 30-32.
- Blaisdell, G.L., V. Klokov, and D. Diemand** (1995) Compacted snow runway technology on the Ross Ice Shelf near McMurdo, Antarctica. In *Contributions to Antarctic Research IV, Antarctic Research Series*, Vol. 67, American Geophysical Union, p. 153-173.
- Brandt, R.E., and S.G. Warren** (1993) Solar-heating rates and temperature profiles in Antarctic snow and ice. *Journal of Glaciology*, 39(131): 99-110.
- DenHartog, S.L.** (1993) Field survey of potential airstrip locations, Mt. Howe, Antarctica 1991. USA Cold Regions Research and Engineering Laboratory, Special Report 93-1.
- Engler, M., A. Guichard, Y. le Tavernier, and J.-F. Regrettier** (1990) The Dumont D'Urville aero-

- drome, Terre Adelie, Antarctica. *Cold Regions Science and Technology*, **18**: 191–213.
- Federal Aviation Administration** (1989) *Airport Design*. U.S. Department of Transportation, FAA, Advisory Circular 150/5300-13.
- Federal Aviation Administration** (1990) A guide to ground vehicle operations on the airport. Office of Airport Safety and Standards, Airport Safety and Operations Division, Washington, D.C., DOT/FAA/AS-90-3.
- Fukami, H., and K. Kojima** (1980) Experimental study of local temperature increases within a snow cover. *Low Temperature Science*, Series A, no. 39, p. 109–117.
- Gerardi, A.G.** (1978) Dynamic response of aircraft to pavement unevenness. In *Research in Airport Pavements, Proceedings of a Conference by the Transportation Research Board, Atlanta, Georgia, 15–17 November 1976*. National Academy of Sciences, Special Report 175, p. 91–96.
- Hamza, H., and D.B. Muggeridge** (1979) Plane strain fracture toughness (K_{Ic}) of fresh water ice. *POAC 79*, p. 697–707.
- Holmes, R.E.** (1995) An investigation into the use of automatic weather station data for the forecasting of high wind speed events at Pegasus runway, Antarctica. Technical Report, Space Science and Engineering Center, University of Wisconsin, Madison.
- Huffman, J.W.** (1983) Williams Field: The history of an icy aerodrome. *Antarctic Journal*, **28**(2): 1–5.
- Kalifa, P., G. Ouillon, and P. Duval** (1992) Microcracking and the failure of polycrystalline ice under triaxial compression. *Journal of Glaciology*, **38**(128): 65–76.
- Keller, L.M., G.A. Weidner, C.R. Stearns, and M.T. Whittaker** (1995) Antarctic automatic weather station data for the calendar year 1993. Department of Atmospheric and Oceanic Sciences, University of Wisconsin, Madison, Wisconsin.
- Klovov, V., and D. Diemand** (1995) Glaciology of the McMurdo Ice Shelf in the area of air operations. In *Contributions to Antarctic Research IV, Antarctic Research Series*, vol. 67, American Geophysical Union, p. 175–195.
- Kovacs, A., and G. Abele** (1977) Runway site survey, Pensacola Mountains, Antarctica. USA Cold Regions Research and Engineering Laboratory, Special Report 77-14.
- Lang, R.M., and G.L. Blaisdell** (1997) Berm condition and natural snow removal at the Pegasus runway, McMurdo, Antarctica. *Cold Regions Science and Technology*, in press.
- Lang, R.M., and G.L. Blaisdell** (1996) Localized surface ice weakness on a glacial ice runway. *Journal of Glaciology*, **42**(141): 426–439.
- Lunardini, V.J., and J. Rand** (1995) Thermal design of an Antarctic water well. USA Cold Regions Research and Engineering Laboratory, Special Report 95-10.
- Mellor, M.** (1977) Mechanics of cutting and boring, Part IV: Dynamics and energetics of parallel motion tools. USA Cold Regions Research and Engineering Laboratory, CRREL Report 77-7.
- Mellor, M.** (1988) Hard-surface runways in Antarctica. USA Cold Regions Research and Engineering Laboratory, Special Report 88-13
- Mellor, M.** (1993) Notes on Antarctic aviation. USA Cold Regions Research and Engineering Laboratory, CRREL Report 93-14.
- Mellor, M., and C. Swithinbank** (1989) Airfields on Antarctic glacier ice. USA Cold Regions Research and Engineering Laboratory, CRREL Report 89-21.
- Nuttall, J.B., and N.R. Morgenstern** (1972) Compression tests on fresh water ice., *APOA Project 16*.
- O'Massey, R.C.** (1978) Aircraft pavement loading: Static and dynamic. In *Research in Airport Pavements, Proceedings of a Conference by the Transportation Research Board, Atlanta, Georgia, 15–17 November 1976*. Special Report 175 published by the National Academy of Sciences, p. 75–83.
- Paige, R.A.** (1966) Ice and snow terrain features, McMurdo Station, Antarctica. Naval Civil Engineering Laboratory, Technical Note N-840, September.
- Paige, R.A.** (1968) Sub-surface melt pools in the McMurdo Ice Shelf, Antarctica. *Journal of Glaciology*, **7**(51): 511–516.
- Russell-Head, D.S., and W.F. Budd** (1989) Compacted-snow runways: Guidelines of their design and construction in Antarctica. USA Cold Regions Research and Engineering Laboratory, Special Report 89-10.
- Schulson, E.M.** (1990) The brittle compressive fracture of ice. *Acta Metallurgica et Materialia* **38**(10): 1963–1976
- Schulson, E.M., D.E. Jones, and G.A. Kuehn** (1991) The effect of confinement on the brittle compressive fracture of ice. *Annals of Glaciology*, **15**: 216–221.
- Sonnenburg, P.N.** (1978) Analysis of airport runway roughness criteria. In *Research in Airport Pavements, Proceedings of a Conference by the Transportation Research Board, Atlanta, Georgia, 15–17 November 1976*. Special Report 175 published by the National Academy of Sciences, p. 96–97.

- Swithinbank, C.** (1970) Ice movement in the McMurdo Sound area of Antarctica. International Association of Scientific Hydrology, Publication no. 86, p. 472–487.
- Swithinbank, C.** (1989) Ice runways near the South Pole. USA Cold Regions Research and Engineering Laboratory, Special Report 89-19.
- Swithinbank, C.** (1991) Potential airfield sites in Antarctica for wheeled aircraft. USA Cold Regions Research and Engineering Laboratory, CRREL Report 91-24.
- Swithinbank, C.** (1992) Non-government aircraft in the Antarctic 1991/92. *Polar Record*, **28**(166): 232.
- Swithinbank, C.** (1993a) Non-government aircraft in the Antarctic 1992/93. *Polar Record*, **29**(170): 244–245.
- Swithinbank, C.** (1993b) Airborne tourism in the Antarctic. *Polar Record*, **29**(169): 221.
- Swithinbank, C.** (1994) Non-government aircraft in the Antarctic 1993/94. *Polar Record*, **30**(174): 221.
- U.S. Army and Air Force** (1968) Planning and design of roads, airbases, and heliports in the theater of operations. Dept. of the Army Technical Manual TM 5-330, Dept. of the Air Force Manual AFM86-3, Vol. II. September.
- U.S. Navy** (1982) Facility planning factor criteria for Navy and Marine Corps shore installations. Naval Facilities Engineering Command report NAVFAC P-80.3.
- U.S. Navy** (1987) Airplane strength and rigidity: Ground loads for Navy acquired airplanes. Naval Air Engineering Center, Systems Engineering and Standardization Department, Lakehurst, New Jersey, Military Specification MIL-A-8863B(AS). (Available from Global Engineering Documents, Irvine, California.)
- Wills, R.H.** (1989) Analysis of surface roughness at blue-ice sites. Appendix B in USA Cold Regions Research and Engineering Laboratory, CRREL Report 89-21.
- Wu, R., A.J. Freeman, and G.B. Olson** (1994) First principles determination of the effects of phosphorus and boron on iron grain boundary cohesion. *Science*, **265**: 376–380.

APPENDIX A: METEOROLOGICAL ANALYSES OF THE PEGASUS RUNWAY SITE

AUSTIN HOGAN

INTRODUCTION

Glacial ablation areas are attractive as sites for Antarctic airstrips (Mellor and Swithinbank 1990). These areas are characterized by net loss, rather than accumulation of snow in the recent climatic era, and usually they display relatively even ice surfaces with good load bearing capability. Often, strong winds are responsible for keeping these areas snow free. The same winds characteristic of many ablation areas may possibly be sufficiently frequent to make use of such an airstrip challenging or dangerous. However, the strong winds may diminish in the brief Antarctic summer, allowing an airstrip to operate during its most needed time. This Appendix discusses for the Pegasus site, available recorded meteorological data, analysis of the fragmentary data from recent and historic visits to the area, and an analytical approach for establishing some characteristics of the spring and summer in this region.

METEOROLOGICAL OBSERVATIONS AT THE PEGASUS SITE

Concurrent with site evaluation and initial engineering work to evaluate the Pegasus site for wheeled runway potential, two AWS were positioned near what would be the runway ends. They are designated "Pegasus North" and "Pegasus South." Data gathered by the AWS were aimed at providing insight to the local meteorology. The AWS data are quite fragmented during the late winter (August–September) surrounding the WINFLY (winter fly-in) opening of the new Antarctic summer season. The data become more frequent during the spring (15 October–30 November), and are quite complete during the peak of the Antarctic summer (8 December–14 January). The AWS designated "Pegasus North" provides the more complete data set and is used almost exclusively in the following analysis.

Periods of calm or winds from the generally benign westerly sectors are rare during August and September. The most frequent winds are from the northeast and east, and about one-third of the time they exceed 5 m/s. The air temperature in-

creases slightly as wind speed increases in the easterly sectors, but temperatures less than -30°C were recorded concurrent with all wind speeds less than 11 m/s. A seeming anomaly of the Ross Ice Shelf is that relatively warm air arrives on strong winds from the polar direction. Storm winds with air warmer than -20°C and speeds of 11 to 21 m/s are relatively common in the southeast and south sectors in September.

October, and sometimes early November, present weather that frustrates air operations at McMurdo. At the Pegasus site, winds are somewhat stronger than at Williams Field, and sub-zero ($^{\circ}\text{F}$) air accompanies fair weather winds until early November. Surface air then warms as fair weather winds weaken, but strong storm winds from the south to southeast persist, sometimes through the first week in December.

The summer at Pegasus is characterized by lower wind speeds, air temperature near 0°C , and an absence of winds from the warm stormy south sector. Summer coincides with the high sun, beginning by 8 December, and ending shortly after 14 January. The most frequent winds are from north to east directions, apparently influenced by downslope winds from Ross Island. There is a diurnal variation in wind direction on nearly one-half of the summer days, when westerly surface winds accompany the sun's passage over the Royal Society Range. The last half of summer has even lower wind speeds, and a more noticeable diurnal variation than the first half.

Frequent aircraft operations from the Pegasus runway should consider the following general meteorological trends.

Sustained strong winds occur throughout winter and spring from the south-southeast. These winds are considerably warmer than would be expected from examining climatic records from McMurdo or Scott Base, and may produce unusual drift patterns due to their warmth. Operational information may be obtained by monitoring the air temperature at AWS situated south of Pegasus on the Ross Ice Shelf. Since warming accompanies acceleration of the surface wind, the initial warming occurs on the southerly extremes of the shelf, and the wind speed increases as the warm air proceeds north.

Sustained winds of greater than 5 m/s may arrive at Pegasus from the calmer “fair weather” northeast sector in spring. These speeds are sufficient to initiate drifting, and are a crosswind relative to the Pegasus runway. The placement of berms, temporary structures, and cargo storage should be guided by knowledge that a strong northeasterly can occur on an otherwise fine day.

Wind from the sectors northwest to southwest are rare at Pegasus during winter and spring, and are not strong in summer. This sector should provide the least influence to buildings and storage associated with runway operations.

Any melting experienced around the runway would appear to be a result of solar warming,

rather than by advected heat. Although wind from the northerly sector (the direction of open water) is more frequent in summer; it occurs less than 10% of the time. Air temperatures above 0°C are recorded on many summer days, but rarely throughout the day. The warm air observed apparently results from adiabatic heating of katabatic downflows and probably conserves its subfreezing frost point while transiting the shelf. This might cause sublimation of the surface, and provide transport of water vapor from the site, but should not advectively exchange heat with the surface to produce the liquid water sometimes observed. Wind direction frequency is shown for the Pegasus South AWS in Figure 21 (main text).

APPENDIX B: ENVIRONMENTAL IMPACT ASSESSMENT FOR THE PEGASUS RUNWAY

Development of Blue-Ice and Compacted-Snow Runways in Support of the U.S. Antarctic Program*

National Science Foundation
Office of Polar Programs
Washington, DC
9 April 1993

INTRODUCTION

The U.S. Antarctic Program (USAP) is proposing to develop one or more runways suitable for wheeled aircraft to support its scientific activities. Concepts for such runways include "blue-ice"[†] runways on glacier ice and runways on compacted snow. The Supplemental Environmental Impact Statement (SEIS) on the USAP (NSF 1991) identified the development of such runways as an ongoing USAP planning activity. The purpose of this Initial Environmental Evaluation (IEE), the equivalent of an Environmental Impact Assessment, is to evaluate in more detail potential environmental impacts that might result from developing blue-ice and compacted-snow runways. This IEE is prepared by USAP in compliance with the National Environmental Policy Act, the Antarctic Treaty, and the Protocol on Environmental Protection to the Antarctic Treaty (the Madrid Protocol) adopted by 26 countries in 1991.

BACKGROUND

The National Science Foundation (NSF) is responsible for the U.S. Antarctic Program (USAP)

* Prepared by: Sidney Draggan, Jane Dionne, Peter E. Wilkniss, Erick Chiang, and Dwight D. Fisher; National Science Foundation, Office Of Polar Programs. George L. Blaisdell, Stephen L. DenHartog, and Wayne Tobiasson; Cold Regions Research and Engineering Laboratory. Robert M. Reed, Lance B. McCloud, J.T. Ensminger, J. Warren Webb, Richard B. McLean, and Jeremy Holman; Oak Ridge National Laboratory, Assessment Support.

[†] In the context of this document, blue ice refers to both naturally exposed ice in ablation regions and ice in the "superimposed ice" region of glaciers and ice shelves. The Pegasus runway is located on superimposed ice.

that supports a substantial scientific research program in Antarctica, often in cooperation with other countries. The USAP maintains three year-round stations in Antarctica: McMurdo Station on Ross Island, the Amundsen-Scott South Pole Station, and Palmer Station on the Antarctic Peninsula (Fig. B1). McMurdo Station is the major base for providing logistic support to numerous scientific field camps on the continent each austral summer. Logistic and operational support is provided by the Department of Defense (Naval Support Force Antarctica, U.S. Army, and U.S. Air Force), the U.S. Coast Guard, and a civilian contractor (currently Antarctic Support Associates, Inc.).

An essential component of USAP logistic support is provided by aircraft that transport personnel and cargo to McMurdo, the South Pole, and field sites during the austral summer season (October through February). A runway for wheeled aircraft is constructed on the annual sea-ice at the start of each season and is used until early December when the sea ice begins to deteriorate. Wheeled aircraft, including C-130 Hercules, C-141 Star Lifters, and C-5 Galaxies, are able to land on the annual sea-ice runway. They provide the majority of the air transport needed for the initial stages of USAP activities each season. During the rest of the season (December through February), fixed-wing aircraft support is limited to ski-equipped LC-130 aircraft and smaller aircraft (for example, ski-equipped Twin Otters) that can land on skiways at Williams Field near McMurdo, the South Pole Station, and field sites. Availability of runways suitable for landing wheeled aircraft during other parts of the season (or if feasible, throughout the year) would greatly enhance USAP's ability to support science activities and help the program streamline its logistic support efforts by increasing the flexibility and efficiency of aircraft operations.

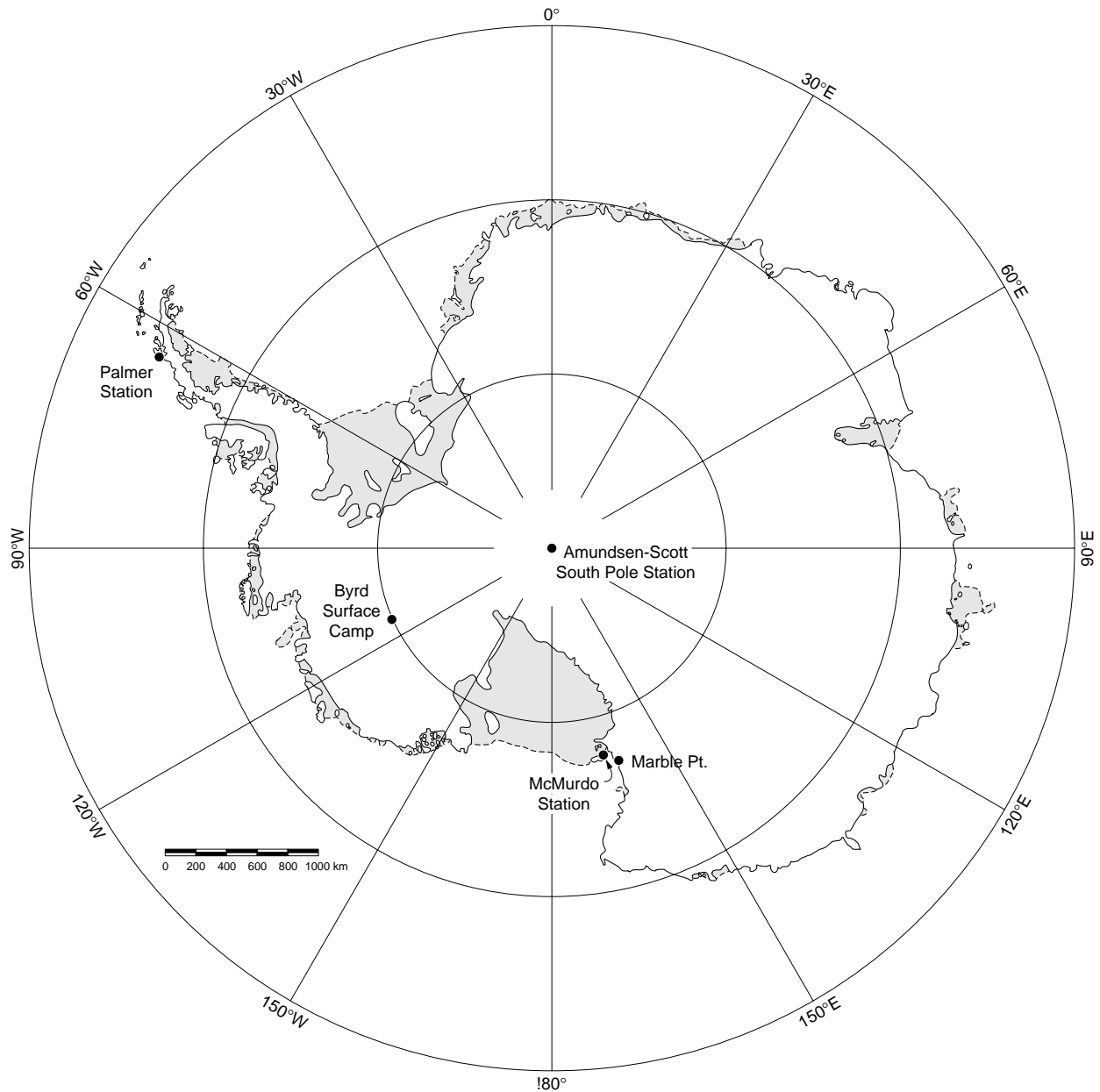

Figure B1. Location of USAP stations on the Antarctic continent.

PHILOSOPHY OF THE U.S. ANTARCTIC PROGRAM IN MINIMIZING ENVIRONMENTAL IMPACTS

Reducing human impacts on the Antarctic environment is a major goal of the USAP. Enhancing the use of wheeled aircraft can help meet the goal of streamlining Antarctic operations. Aircraft are essential for supporting scientific research, but their fuel, emissions, and the personnel

required to operate and maintain them can cause environmental impact on Antarctica. Wheeled airplanes are appreciably more efficient in that they use less fuel and can carry more cargo than similar aircraft equipped with skis. Replacing ski-equipped planes with wheeled aircraft could reduce the number of flights, the consumption of fuel, and the generation of emissions and maintenance-related wastes required to support USAP scientific and operational activities.

The operating philosophy of the USAP (Dragan and Wilkniss 1993) recognizes the potentially profound impacts that its presence and its activities can have upon Antarctica. This philosophy acknowledges the importance of the various components of the human environment, the Antarctic environment, and the interactive processes that give structure to those environments. The philosophy goes further in affirming that USAP will use all practicable means and measures to foster and maintain Antarctica's natural conditions while promoting and supporting Antarctic scientific endeavors in a manner that is safe and healthful for USAP participants.

The USAP's operating philosophy is based upon several broad, yet reasonable and practical, assumptions. The assumptions are that 1) the Antarctic Continent can be viewed, in the main, as a closed environment, 2) inputs to, and outputs from, the operating environments of the USAP (that is, its stations, field camps and vessels) can be controlled, 3) while all human activities entail some measure of change or impact to the environment, those changes and impacts can be minimized, mitigated, or controlled, and 4) effective minimization, mitigation, and control of change or impact depends on information-intensive approaches that foster early consideration of potential changes or impacts.

In keeping with this philosophy, this IEE focuses on actions or changes to program activities that might: 1) reduce human impacts by reducing the need for Antarctic personnel and nonscience support operations, 2) foster environmentally compatible use of such natural Antarctic substrates as ice and snow, and 3) promote reductions in peaks of operational activity by providing opportunities for year-round program operation.

SCOPE OF THE IEE

This IEE evaluates the impacts associated with developing blue-ice and compacted-snow runways in general, as well as current proposals to develop such runways at the Pegasus site near McMurdo Station and at Mill Glacier or Mount Howe. The intent is to provide sufficient evaluation to ensure that adequate review of potential environmental impacts for planned developments of such runways has been done and appropriate documentation prepared. This analysis will be reviewed for future developments, and supple-

mental analysis and documentation will be prepared for such developments as necessary.

PROPOSED ACTION AND ALTERNATIVES

The proposed action is to develop a limited number of blue-ice or compacted snow runways to support USAP activities. The proposed action includes development of a runway at the Pegasus site near McMurdo to allow use of wheeled aircraft and at Mill Glacier or Mount Howe. Alternatives include consideration of other locations and construction techniques.

Purpose

The purpose of the proposed action is to construct and operate blue-ice and compacted-snow runways in Antarctica that would be used by wheeled aircraft and would enhance air support for USAP activities throughout the austral summer season and possibly throughout the year. In the near term, USAP is exploring the possibilities of developing: 1) a blue-ice or compacted-snow runway on the permanent ice shelf near McMurdo Station that could be used by wheeled aircraft late in the season, and 2) a blue-ice or compacted-snow runway that could be used by wheeled aircraft to support construction activities at the South Pole Station. In addition, blue-ice or compacted-snow runways may also be developed elsewhere in Antarctica in the future to support USAP scientific and logistic support activities.

Runways suitable for wheeled aircraft could be important in emergencies. In August 1987, NSF Director Erich Bloch convened a panel of experts to review safety in the USAP (USAP Safety Review Panel 1988). The panel was tasked to review "...all aspects of safety in NSF, DOD, U.S. Coast Guard, support contractor, and science team operations." Two of their recommendations are relevant to this proposed action. Recommendation AOP-2 was that "...the National Science Foundation should consider evaluating 'blue-ice' areas as potential LC-130 landing sites to provide greater flexibility for science and operational purposes." Recommendation AOP-3 was "...to investigate and define the means by which both early (or episodic) and year-round access to McMurdo can be provided safely." Part of the motivation for both these recommendations was better access in emergencies.

Need for a blue-ice or compacted-snow runway at McMurdo

Currently, wheeled aircraft fly to and from McMurdo Station between October and early December when a hard-surfaced, annual sea-ice runway is available. At other USAP sites on the continent, including the South Pole Station, ski-equipped aircraft land on prepared skiways. When the McMurdo annual sea-ice runway is shut down in December, fixed-wing aircraft support is restricted to a limited number of ski-equipped aircraft owned or chartered by USAP. The USAP currently owns six ski-equipped LC-130s and may charter two additional ski-equipped LC-130s from the Air National Guard, that usually are available in November and January. In addition, USAP may charter one or two Twin Otters (or similarly equipped aircraft) to support science projects and provide other types of support (for example, reconnaissance surveys).

From December through February, LC-130s are used to provide both intercontinental air transport between New Zealand and McMurdo and intracontinental support to the South Pole and field sites beyond the range of helicopter operations. The small number of large ski-equipped aircraft available limits both the amount of science that can be supported in January and February and the program's flexibility in accommodating unanticipated needs.

A blue-ice or compacted-snow runway near McMurdo that would operate in late January through February would allow wheeled aircraft to transport personnel leaving Antarctica at the end of the austral summer season back to New Zealand. Wheeled aircraft would carry more passengers per flight and would require fewer trips than would LC-130s. By using wheeled aircraft at McMurdo late in the season, LC-130s that are currently used to redeploy personnel to New Zealand would be available to provide additional support for science at the South Pole Station and field sites. If more research were to take place on a continuous, year-round basis, the capability to land aircraft at McMurdo year-round would be a major advantage in terms of safety. Year-round access is not being considered by USAP at this time. If it should be deemed feasible in the future, USAP would conduct additional environmental review to assess the potential environmental impacts and would prepare appropriate documentation.

Need for a runway to support construction activities at the South Pole Station

Another need for a blue-ice or compacted-snow runway is to facilitate the transport of construction materials that would be needed for any reconstruction or replacement of the South Pole Station within the next ten years. Although the reconstruction or replacement of the South Pole Station would be addressed in detail in separate environmental documentation, the development of a blue-ice or compacted-snow runway to support this action is addressed in this IEE. Use of LC-130s for transporting construction materials could significantly reduce their availability to support the science program at the South Pole and elsewhere.

Need for runways to support field camps or enhance safety

Other blue-ice runways may be developed by USAP to provide 1) alternative landing sites for wheeled aircraft if the sea-ice runway at McMurdo is shut down by poor weather conditions, 2) a refueling site for wheeled aircraft flying from South America to McMurdo, or 3) logistic support bases for future science projects. The need for such sites would be defined to enhance safety, to make the best use of the limited LC-130 assets, and to limit the number of flights required.

ALTERNATIVE ACTIONS

Alternatives considered in this IEE fall into three groups, as follows: 1) alternatives for enhancing use of wheeled aircraft at McMurdo Station, 2) alternatives for improving air logistics support to the South Pole Station, and 3) alternatives for improving wheeled aircraft support to USAP activities elsewhere on the continent. These three groups of alternatives are discussed in the following sections.

Enhancement of wheeled aircraft capabilities near McMurdo Station

Actions considered in this section include 1) the proposed action of developing a blue-ice or compacted-snow runway at the Pegasus site near McMurdo Station (Fig. B2); and 2) the no-action alternative of continuing the current practice of using a combination of a sea-ice runway and skiway at McMurdo.

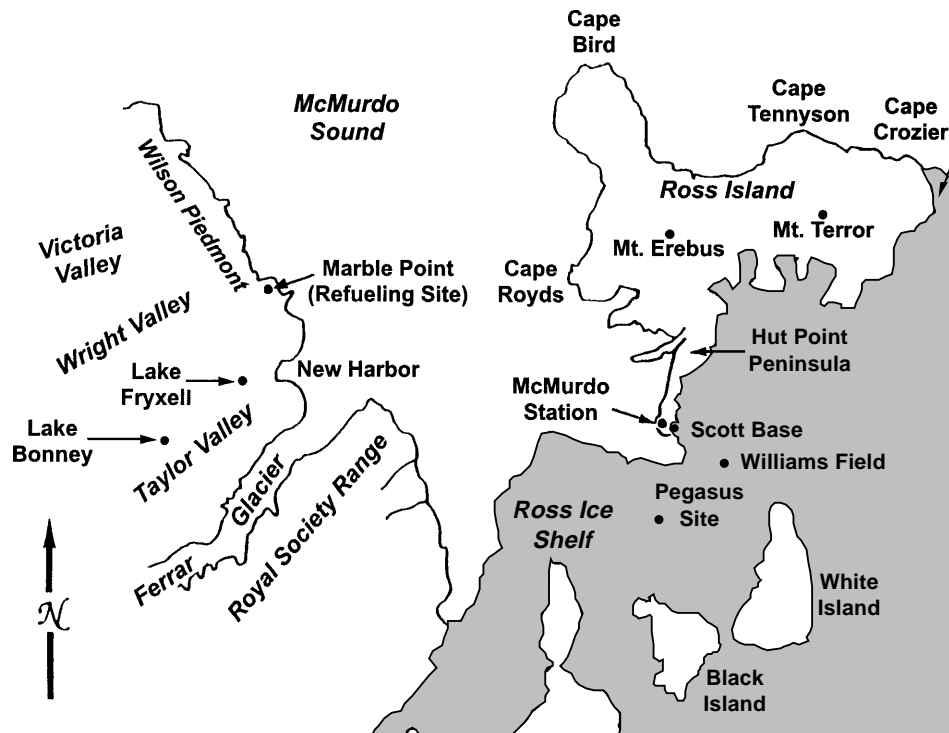

Figure B2. McMurdo Sound and vicinity. (From NSF 1991.)

Development of a compacted-snow runway at the Pegasus site (Pegasus I)

The USAP, with the assistance of the Cold Regions Research and Engineering Laboratory (CRREL), has been investigating the feasibility of constructing either a compacted-snow (Pegasus I) or a blue-ice runway (Pegasus II) at the Pegasus site since 1987 (Fig. B3). The Pegasus site is the only blue ice (snow ablation zone) in reasonable proximity to McMurdo Station. A Pegasus runway would be 10,500 ft long and would be located on the ice shelf between Black and White Islands, known as "Herbie Alley," oriented approximately north-south towards McMurdo (Fig. B3). As noted earlier, the main use is anticipated to be redeployment of personnel at the end of the austral summer season in February. Once proven, the possibility of using the runway for winter fly-in ("WINFLY") and of accessing McMurdo Station during the winter may be considered.

Work at the Pegasus site was initiated during the 1989-90 season and has continued through the 1992-93 season. Environmental impacts of the experimental work performed were addressed in an Environmental Action Memorandum (NSF 1990) prepared in October 1990.

The concept for the Pegasus I runway is to prepare a compacted-snow runway by placing and subsequently compacting a thin (25-cm) layer of snow over the blue-ice base (Blaisdell et al. 1992). Initial work on the Pegasus I runway involved stripping off the snow cover into windrows and redistributing the snow with graders and snow planes. The snow was compacted using a variety of machinery that was available at McMurdo and Williams Field. The density of the compacted snow that was obtained was not sufficiently great to support test landings during the first season. When conditions were favorable in the following December (1991), the runway was compacted with a heavy pneumatic-tire roller. Problems were encountered with snow melt at the southern end of the runway and much of the snow cover was lost in January at that end of the runway.

Two test landings were made on the Pegasus runway during the 1991-92 season. An empty LC-130 on a return flight from the South Pole made a ski landing then taxied on wheels the full length of the runway and took off. The second test landing involved a fully loaded LC-130 that took off from Williams Field and then landed on

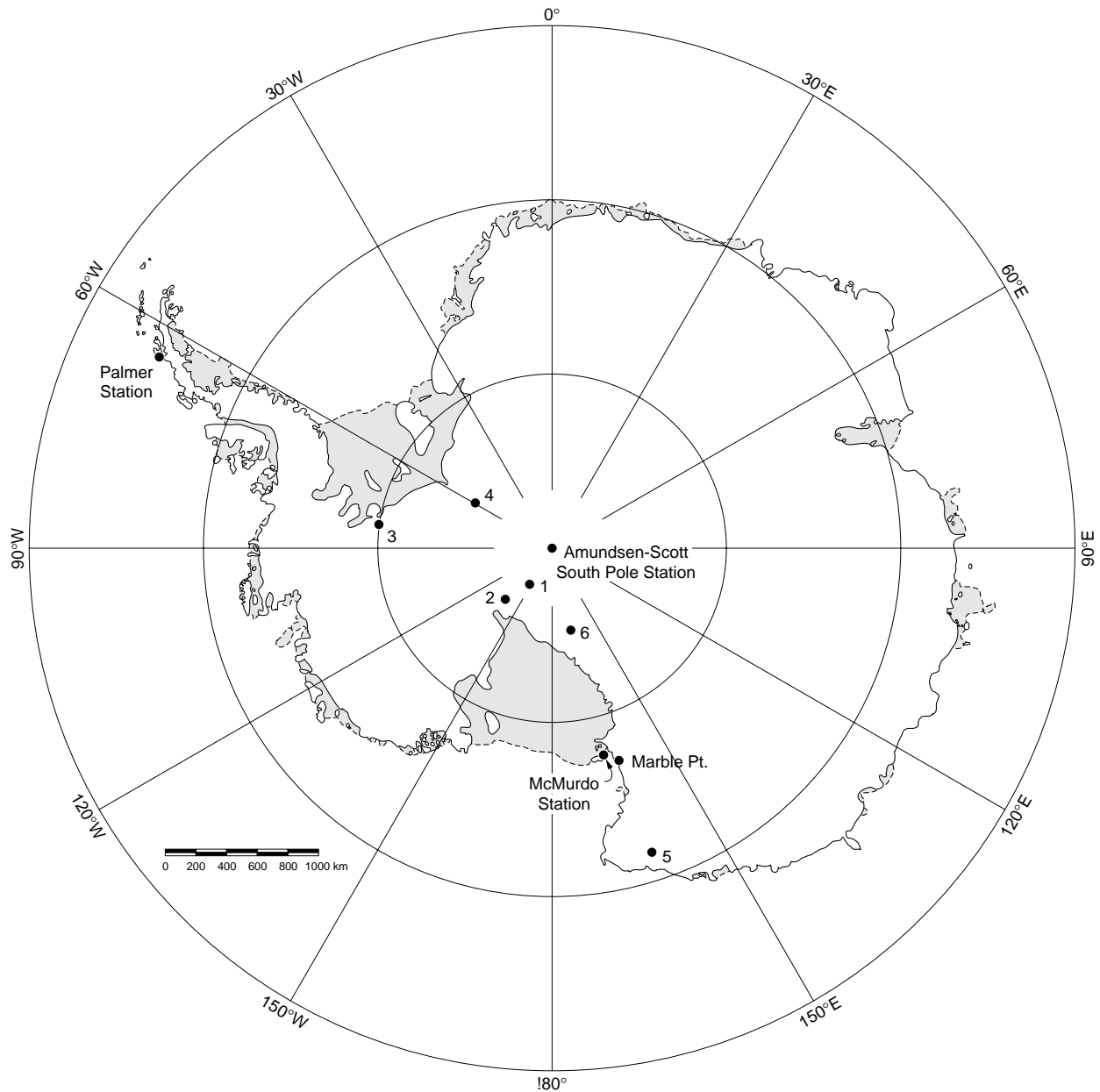

Figure B3. Potential blue-ice runway sites: 1-Mount Howe, 2-Reedy Glacier, 3-Patriot Hills, 4-Patuxent Range, 5-Rennick Glacier, 6-Mill Glacier. (From Swithinbank 1991.)

skis at the Pegasus site. Also, this flight taxied and took off from the Pegasus site on wheels. The results of these test landings and takeoffs were considered to be very successful and have demonstrated that compacted-snow pavements can be made sufficiently strong for wheeled C-130 operations.

Development of the Pegasus I runway is not being pursued at this time. The concept might

be revived if the Pegasus II concept proves to be unworkable. The principal difference between the two is that a considerable amount of effort is required to roll and compact snow to form a firm surface layer upon which wheeled aircraft can land. It is not clear whether the effort required to develop the required surface strength is less or more than required to prepare a blue-ice runway.

*Development of a blue-ice runway
at the Pegasus site (Pegasus II)*

The concept for the Pegasus II runway is to develop a runway directly on exposed blue ice. Because melt pools can form on exposed blue-ice during the warmest periods of the austral summer (November through January), snow would be spread over the exposed surface to protect it from the sun during this time. In late January, this snow cover would be cleared to expose the blue-ice landing surface so that the runway could be used for redeploying personnel to New Zealand.

Because of difficulties with Pegasus I, planning for the 1992–93 season focused on Pegasus II. Early in the season, snow was removed from the proposed Pegasus II runway. Using a laser-guided grader, irregularities and high spots were removed to produce a smooth and nearly level surface. The runway surface successfully supported a test cart equipped to produce loading similar to a C-130 aircraft landing gear. Tests with a cart setup to reproduce the loading of a C-141 aircraft landing gear caused failure of the surface in three spots. These spots are believed to have undergone melting in the previous season. The spots were patched, but trial C-141 landings were postponed to give the patches time to anneal. During the remainder of November, December, and January the surface was covered with snow to prevent melt pool formation. Snow removed from the surface in October was redistributed to minimize the likelihood of drifting that would cover Pegasus II with quantities of snow that would be difficult to remove in subsequent years. In late January and early February 1993, the Pegasus II runway tested satisfactorily for landings of C-130s. Several round-trip flights were made during February to redeploy personnel at the end of the 1992–93 season.

The runway at the Pegasus site was constructed with a 14G laser-guided grader, a snow blower, a snow plane, a bulldozer, two towed rollers, and a load cart (that is, a cart equipped with C-130 or C-141 wheels and loaded with sufficient weight to simulate the pressure of a taxiing C-130 or C-141 aircraft) to test the runway surface. The grader was used for initial preparation to remove bumps or waves in the runway surface, but the overall slope of the surface was not modified. A snow blower was used to clear snow so the surfaces could be prepared, to remove ice cut by the grader, and to cover the prepared surface with snow to prevent formation of melt ponds during the warm-

est parts of the season. Construction of the runway required six people full time, and about the same size crew is required to maintain the snow cover during the November–January period.

Maintenance of the Pegasus II runway is basically a snow management problem. Because of the particular requirements of the Pegasus glacier-ice runway, both snow drifting and activities that reduce the albedo of the ice or snow surface must be carefully controlled. To minimize snow drifts, only the minimum of facilities, primarily fuel tanks, and sanitary and emergency facilities needed to support the 4 to 6 people working at the site would be located there during the warm part of the season. During the austral winter, when the runway is not in use, all structures and navigational aids would be removed.

In addition to constructing the runway surface, shelters would be moved to the site to provide support facilities for the Pegasus site. These shelters, including an emergency shelter, a heated rest facility, and a toilet facility, would initially be portable or temporary facilities. The use of portable structures would reduce long-term problems with drifting snow. If more permanent facilities are needed in the future, they would be elevated above the surface to minimize snow drifting. A crash truck from Williams Field would be stationed at the runway when flights were scheduled. Other emergency vehicles (for example, ambulances) would be available at Williams Field in the event of an accident.

Fuel would be temporarily stored on site to refuel aircraft, and all wastes, with the possible exception of gray water which might be piped through the ice into the sea below, would be taken to McMurdo. Initially, the fuel would be taken to Pegasus in two small tanks mounted on sleds; the empty tanks would be returned to Williams Field. Initially, no precision radar or TACAN would be required, and no power would be generated on site. Testing would probably only require a flagged runway. Should Pegasus be used to extend the season, runway lights would be needed in addition to other navigation aids similar to those used at Williams Field and the sea-ice runway. If the runway proves successful and the facilities take on a more permanent nature, radar installation and power generation also would be required. Fuel would then be stored in a skid-mounted storage tank. Secondary containment for the tanks would be provided to prevent fuel spills onto the snow and ice.

Most aircraft and vehicles used in Antarctica

leak oil and hydraulic fluid. These leaks would have to be controlled and promptly cleaned up at Pegasus because of their effect on the runway's albedo. On sunny days, the increased albedo caused by leaking oil and hydraulic fluid could cause local melting that would damage the surfaces of the runway and taxiway.

Pickup trucks, vans, terra-tire vehicles like Foremost Deltas, or rubber-tracked vehicles like the Caterpillar Challenger would be used to transport personnel and equipment to and from the site initially. Snow that accumulates or drifts on the access roads to the Pegasus site would be leveled and compacted. Routine maintenance of vehicles and equipment would be performed at Pegasus or Williams Field. If necessary, major repairs would be done at McMurdo.

The snow road to the Pegasus site is basically a straight line that runs approximately 13 km from Williams Field. This road comes close to the edge of the ice shelf and would have to be relocated periodically as the ice shelf moves. The ice shelf is moving west at a rate of approximately 100 m/year in this area but at less than half that rate at the Pegasus site. This movement is being monitored.

If the Pegasus II runway development continues to be successful, it would supplement, rather than replace, the sea-ice runway and the Williams Field skiway, primarily at the end of the austral summer season. The annual sea-ice runway would continue to be used because it is inexpensive, its location is very close to McMurdo, and preparation time and effort is minimal. The Williams Field skiway would continue to be used at McMurdo because no hard-surface runway would be available during the warmest parts of the austral summer season (December and January). The Pegasus site would probably be developed gradually and decisions on whether and how long to use it would be made on the basis of experience.

No-action alternative at the Pegasus site

Under the no-action alternative, USAP would continue to use only the annual sea-ice runway and Williams Field as runways for fixed-wing aircraft. The sea-ice runway is constructed each year on annual sea ice as close to McMurdo Station as possible; its exact location may vary from year to year, depending on ice conditions and other considerations. The support buildings associated with the sea-ice runway are mounted on sleds and moved each year to and from Williams Field. Construction of the sea-ice runway begins

in August when additional support personnel are flown to McMurdo to prepare the station for opening. Operation of the runway begins in early October.

The Williams Field skiway is approximately 16 km from McMurdo Station on the Ross Ice Shelf. Williams Field is located on the ice shelf that is moving slowly toward the sea. The skiway and its associated facilities are periodically relocated to avoid loss when the ice calves into McMurdo Sound. These facilities are described in more detail in the SEIS (NSF 1991).

Support for the South Pole Station

The present South Pole Station was completed in 1975 and is being buried by accumulated snow. The station has exceeded its design life, and the current summer population greatly exceeds the number of people for which it was designed. The current station is supported by a skiway that typically operates from late October to late February each year.

As plans are being developed for any new station, the feasibility of transporting the millions of pounds of material and equipment that would be needed using LC-130 aircraft is being examined. Use of the limited LC-130s available for this purpose would have a significant impact on their availability to support current and planned scientific activities at the South Pole Station. Thus, the USAP is investigating the feasibility of transporting materials and equipment in conventional, wheeled aircraft to a blue-ice runway as close to the Station as practicable. Cargo would then be transported the remaining distance by overland traverse tractor-pulled sleds or tracked trailers over the snow/ice surface.

The possibility of developing a blue-ice runway to support reconstruction of the South Pole Station has received considerable attention. Studies by Swithinbank (1989, 1991) and Mellor and Swithinbank (1989) have identified potential blue-ice landing sites throughout Antarctica. These studies have narrowed the sites suitable for supporting reconstruction of the South Pole Station to two that are currently being examined in detail. The Mount Howe site is located about 300 km from the South Pole Station, and the Mill Glacier site is located about 540 km from the South Pole Station (Fig. B4). Sites at Mount Howe and Mill Glacier are being investigated by the CRREL as the closest, potentially feasible blue-ice sites to the South Pole.

Another alternative that is being examined is

to develop a compacted-snow runway at the South Pole Station itself. The feasibility of constructing such a runway is not clear at this point in time, but the advantages of being able to land wheeled aircraft at the South Pole would be enormous.

Other alternatives for transporting construction materials and equipment to the South Pole do not involve development of blue-ice or compacted-snow runways and are beyond the scope of this IEE. These alternatives include overland traverse from McMurdo Station, air drops, and use of dirigibles. The no-action alternative would depend on the use of LC-130s to transport all construction materials and equipment.

Development of a blue-ice runway at Mount Howe

The closest potential blue-ice runway site to the South Pole is at Mount Howe, where the exposed blue-ice surface is suitable as a runway with relatively little smoothing. Twin-Otter aircraft have already landed there on wheels. Intensive summer warming that mandates a protective cover at the Pegasus site during December and January does not occur at Mount Howe. Thus no annual surface protection measures are necessary at this site.

It is expected that wheeled landings can be made on a selected area of the natural blue-ice surface by lightly loaded LC-130s. Surveys are being conducted to locate and mark such an area. LC-130s would land there to deliver equipment to smooth the surface for a longer, smoother permanent runway. The equipment would include a towed road brush which, with the help of the wind, would remove any loosened material from the runway. The only maintenance needed thereafter should be periodic brushing to dislodge patches of snow from the blue-ice surface and the prompt removal of oil and hydraulic fluid that leaks from aircraft and vehicles.

In this fashion it is expected that a suitable surface can be formed on which C-130 and C-5 aircraft could land. It is not yet known if a surface can be produced that would allow C-141 aircraft to land at Mount Howe. Because the U.S. Air Force may not wish to have C-5 aircraft land in such a remote location, it is most likely that C-130s would be used at Mount Howe. While few LC-130 aircraft are available, many C-130s could be made available by the USAF.

The characteristics of the Mount Howe site do not permit the runway to be aligned with the often strong winds present there. The cross-wind

component of these winds would prevent landings at times. In January 1992, an Automated Weather Station was installed at Mount Howe to monitor wind conditions. It is possible that the operational window at Mount Howe will be too small to make it a landing site. Initial reconnaissance of the over-snow traverse route from Mount Howe to the South Pole indicates that the route is potentially crevasse-free and of reasonable slope, except for one area about 12 km from the Mount Howe runway site.

If the Mount Howe site were developed, facilities would be built to accommodate a crew of 6–12 that would operate the airfield, unload the aircraft, and load the traverse sleds (or tracked trailers) and the members of the traverse crews. The Mount Howe runway would operate only during the austral summer, perhaps from late October through early December. However, other developments, such as the Pegasus runway, might make it possible to expand the period during which the Mount Howe airfield is operational. Traverses between Mount Howe and the South Pole could continue independent of flights if sufficient cargo is transported to Mount Howe to warrant them. Aircraft carrying cargo to Mount Howe could originate at either Christchurch, New Zealand, or McMurdo. In specific situations, several aircraft could land at Mount Howe on a given day.

Some heavy equipment would be needed at Mount Howe to unload aircraft and reload the traverse sleds (or tracked trailers) rapidly when they arrive. A building in which this equipment can be stored and maintained would be needed at the site. Platforms would be needed for staging palletized aircraft loads until they are transferred to sleds (or tracked trailers) to keep the cargo and the staging area from being engulfed in drift snow.

Development of a blue-ice runway at Mill Glacier

No runway construction activity would be needed for use of the blue-ice runway at the Plunket Point site on Mill Glacier. Twin-Otter and LC-130s have landed at this site in the past. Operational requirements and maintenance activities would be similar to those at Mount Howe. Because the Mill Glacier site is farther from the South Pole Station than the Mount Howe site (540 km vs. 300 km), additional fuel storage for traverse vehicles would be needed. Cargo transport by tractor train to the South Pole would require more time and fuel than the traverse from Mount Howe.

This additional distance would extend a round-trip traverse from the South Pole to about nine days. To deliver all the cargo and equipment necessary in the time available, several more tractors would be needed.

Development of a compacted-snow runway at the South Pole Station

A wheeled-aircraft runway at the South Pole Station would be the most desirable option from a logistics point of view. Because the South Pole is located in an area of snow accumulation, the runway would be prepared on compacted snow. About 20 cm of new snow accumulates at the South Pole each year. The runway, therefore, would have to be periodically replaced to accommodate the slowly rising snow surface. It may not be economically feasible to continue to resurface the runway after the major construction effort of replacing the South Pole Station is completed. The methods for constructing this type of runway are still experimental, and it is not certain that a runway capable of supporting C-130 aircraft can be built at the South Pole.

The runway would probably be constructed using a device for disaggregating and adding energy to the snow, followed by a roller to compact the snow. A snow plane would be used to smooth the surface. Compaction would take place in layers to build up a snow pavement of the required thickness and support capabilities (Abele 1990). Mellor (1988) identifies several other compaction techniques, such as impact devices, sawdust or chemical additives, melt-freeze bonding by heating or wetting, and airfield mats. Extensive testing would be required to determine the strength of the runway surface and its ability to withstand wheeled aircraft landings. Maintenance of the runway would involve reconstruction of the runway surface layer every year. If such a runway were to prove successful, it would be supported by the South Pole Station personnel and facilities and the number of additional support personnel should be kept to a minimum. All vehicles except aircraft would be serviced and maintained at the South Pole Station.

No-action alternative

Under the no-action alternative, no additional air logistics capabilities using wheeled aircraft would be added to support activities at the South Pole Station. This alternative would make reconstruction or replacement of the South Pole Station

dependent on LC-130 support, airdrop, or traverse from McMurdo. Use of LC-130s would greatly reduce the support available for science during the construction period, and might significantly extend the time required to build the new station.

Other blue-ice runways for science support and enhancing safety

Swithinbank (1991) reviewed approximately 27,000 aerial photographs of Antarctica for ice fields that might be suitable as sites for blue-ice runways. His analysis indicated that many of these areas appeared to be unsuitable for transport aircraft because of slope, grade change, length, crevasses, cross winds, or obstructed approaches. Swithinbank's study identified 84 potential blue-ice runway sites.

A blue-ice area runway at Patriot Hills (80°19'S, 81°W), about 1,075 km from the South Pole, has been used by commercial adventure tour operators since 1987. In addition, Twin Otter landings have been made at the Mill Glacier and Mount Howe sites (Mellor and Swithinbank 1989). Surveys have been conducted at the Rosser Ridge site (82°46'S, 53°40'W) in the Pensacola Mountains and the Mount Lechner site (83°15'S, 51°14'W) in the Forrestal Range (Kovacs and Abele 1977, as cited in Mellor and Swithinbank 1989). Additional reconnaissance is planned of the Reedy Glacier site (85°45'S, 133°00'W) that might provide an advanced base for work on the Siple Coast and other parts of West Antarctica (Fig. B3). Another area that is of interest is an extensive area of blue ice in the Patuxent Range of the Pensacola Mountains (Fig. B3) that could provide an advance base of operations for work in the direction of the Weddell Sea and the Antarctic Peninsula. Areas of possible interest as emergency landing fields for conventional aircraft flying between McMurdo and New Zealand would be those within a 280-km radius northwest of McMurdo and a site at the Rennick Glacier (71°30'S, 162°15'E) (Fig. B3).

AFFECTED ENVIRONMENT AND ENVIRONMENTAL CONSEQUENCES

Pegasus site

Affected environment

The Pegasus site (166°35'E, 78°S) is located about 13 km east of Williams Field on the Ross Ice Shelf

(Fig. B2 and 13, main text). The site is just within the accumulation zone of the ice shelf. The winds in the area are variable, and there are no rock exposures in the vicinity. No wildlife resources are present at the site itself, although skuas and other animals (for example, seals or penguins) occasionally do move into the area. White Island, a Site of Special Scientific Interest (SSSI), is approximately 15 km from the Pegasus site. McMurdo Sound lies approximately 13 km to the northwest and is an important area for marine mammals and birds. Weddell seals, Adelie penguins, and Emperor penguins use the area for breeding. Historically, seal and penguin populations have been affected by human populations in the McMurdo vicinity (for example, used as a food supply for dogs), but currently impacts are minimal and limited to scientific studies and the presence of humans in the area (NSF 1991).

Environmental consequences of developing a runway at the Pegasus site

Construction and operational impacts of a blue-ice or compacted-snow runway at the Pegasus site are expected to be negligible. The area is approximately 13 km from McMurdo on the Ross Ice Shelf and does not provide habitat for any terrestrial or aquatic plant or animal life. Operation of construction equipment would result in small amounts of combustion products emitted to the atmosphere and small amounts of oil, lubricants, and fuel leaked onto the ice surface. A temporary building would provide shelter and office space for the construction crew, and additional moveable buildings would be located at the site once the runway was successfully tested to provide an emergency shelter, a heated rest facility, and a toilet facility.

Fuel spills could occur during refueling of aircraft and equipment at the site. In the early stages of operation, fuel would be transported to the site in small tanks mounted on sleds. If operations increase, a large fuel storage tank would be moved to the site. Spills or leaks of oil, fuel, lubricants, and other fluids from aircraft, runway construction and maintenance equipment, vehicles to transport people and cargo, support buildings and facilities, and fuel storage sites would decrease the surface albedo and could result in deterioration of the snow and ice surface. To prevent surface deterioration and contamination of the environment, spills and leaks would be cleaned up as quickly as possible by using absorbents.

Contaminated snow and ice would be scraped up, placed in containers, and transported to McMurdo for removal of contaminants, if feasible, and retrograding. Clean snow would be spread on affected areas to prevent further deterioration.

Although the site does not support any wildlife populations that would be affected by construction or operation, Weddell seal populations occur at SSSI No. 18 on the north-west side of White Island and in the vicinity of Scott Base and McMurdo Station. Aircraft landing and taking off from the Pegasus site would be directed not to fly over SSSI No. 18 to avoid any disturbance to seal populations there. Wildlife in the vicinity of Scott Base and McMurdo have become accustomed to aircraft operations, and aircraft landings farther away at Pegasus are unlikely to disturb these populations.

Atmospheric emissions from aircraft, support vehicles, and power generators at Pegasus would occur. Such emissions would be similar to, but less than, those presently generated at McMurdo and would be a very small addition to present emissions. No significant deterioration of air quality would be anticipated from construction and operation of the Pegasus site.

Solid and liquid wastes produced at the site during construction and operation would be transported to McMurdo for appropriate disposal. Sanitary wastes would be collected in barrels that would be returned to McMurdo and emptied into the McMurdo wastewater system. Periodically, the site would be policed to remove trash, dunnage, and barrels. Pallet supports used for baggage and cargo would be returned to McMurdo for reuse.

Environmental consequences of the no-action alternative at the Pegasus site

The no-action alternative would result in no development of a blue-ice or compacted-snow runway at the Pegasus site. Impacts of existing operations at the sea-ice runway and Williams Field are addressed in the SEIS (NSF 1991). If the Pegasus site is not developed, no additional activities would occur at the site, no impacts from future development activities would occur, and the existing test runways would quickly return to a natural state. Use of wheeled aircraft for redeployment at the end of the season would not be possible, and the potential for extending the season would not exist.

Mount Howe site and Mill Glacier sites

Affected environment

Mount Howe (87°20'S, 149°50'W), located in the Transantarctic Mountains, is the closest blue-ice runway site to the South Pole (about 300 km) (Fig. B3). The site (elevation 2,400 m) is located immediately west of the Mount Howe ridge (elevation of peaks about 2,930 and 2,790 m) and associated moraines. The area of interest is relatively smooth and free of crevasses and snow drifts. It is about 7 km long, running in a NNE–SSW direction, and its width, which is limited by crevasses to the west, ranges from about 2–3 km. The prevailing winds are from the mountain ridge. An automated weather station was installed at the site during the 1991–92 season. The area supports no plants or animals.

The Mill Glacier site (85°06'S, 167°15'E) is a blue-ice area located near Plunket Point in the Transantarctic Mountains about 540 km from the South Pole (Fig. B3). Mill Glacier is a valley glacier that flows down from the Grosvenor Mountains, past the Otway Masif, and down between the Dominion Range and the Supporters Range, joining the Beardmore Glacier near Plunket Point. The site is at an elevation of about 1,800 m and is bounded on the west by the Meyer Desert, an ice-free rock massif, and on the east by giant rifts in the glacier surface (Mellor and Swithinbank 1989). The crevasse-free area within which an airfield could be located is more than 7 km long, running in a NNW–SSE direction, and varies in width from 1 km at the northern end to 100 m at the southern end. The wind direction appears to be 160 true. The site does not support any animal or plant life.

Environmental consequences of developing blue-ice runways

Impacts of developing a blue-ice runway at Mount Howe or Mill Glacier would be similar to those of developing a blue-ice runway at the Pegasus site. Because these two sites are located on the Polar Plateau, no plant or animal life would be affected by construction or operation activities. Spills or leaks of oil, fuel, lubricants, and other fluids from aircraft; runway construction and maintenance equipment; vehicles to transport people and cargo; support buildings and facilities; and fuel storage sites could result in deterioration of the ice surface. These spills or leaks would be cleaned up. Such cleanup would

be faster and much easier because spilled fluids would not soak into porous snow but rather would remain on the ice surface. Impacts of atmospheric emissions from aircraft and equipment are expected to be negligible because of the small number of flights, the limited size of the support facilities, and the remote location. Some deterioration of the pristine environment immediately surrounding these sites would result, but in general the impact would be less than minor or transitory (that is, of no significance). Solid, liquid, and sanitary wastes would be collected and returned to McMurdo for appropriate disposal.

Development of blue-ice runways at these sites would also involve development of traverse routes to the South Pole Station. Environmental impacts of these traverse routes are not assessed in this IEE, but they will be assessed in environmental documentation prepared for any rebuilding or replacement of the South Pole Station.

Development of these runways would indirectly impact the South Pole Station because of the need for increased personnel and support needed at the South Pole during initial construction and annual rebuilding of the runway.

Environmental consequences of the no-action alternative

If blue-ice runways were not developed at Mount Howe or Mill Glacier, no additional environmental impacts would occur from USAP activities at these sites. No buildings would be located at the sites, and human presence at the sites would not increase. Mill Glacier has already been used for landings and may continue to be used for such purposes in the future. However, the site would not be developed for providing support to the South Pole and future use is likely to be restricted to support for field camps.

South Pole Station

Affected environment

The South Pole Station is located on the Polar Plateau at an elevation of 2,900 m. The high plateau causes persistent and predictable winds to blow down slope toward the perimeter of the continent. The circulation of coastal storms affects surface winds at the South Pole infrequently. Consequently, peak winds at the South Pole are quite low in comparison with those in coastal areas of Antarctica. Temperatures measured at the South Pole have ranged from a minimum of –80.6°C to a maximum of –13.6°C. The mean

monthly temperatures range from about -60°C in July and August to about -28°C in December and January. The mean annual temperature is -49.3°C (Schwerdtfeger 1984). Precipitation at the South Pole is either light snow or, more frequently, ice crystals. The estimated annual average accumulation is 7 cm of water equivalent (Schwerdtfeger 1984).

Snow is lost only by ablation or blowing toward the edge of the continent. Snow has accumulated and formed an ice cap over the continent about 2,850 m thick. This ice sheet moves about 10 m/year toward the Weddell Sea (Giovinetto and Bentley 1985). The South Pole site includes the current station completed in 1975 and former facilities now covered by snow. Because the South Pole Station is located on the high-altitude, inland plateau, there are no aquatic or terrestrial ecological resources.

Environmental consequences of developing a compacted-snow runway

Construction of a compacted-snow runway is expected to have only “minor or transitory” (that is, no significant) environmental impacts. Additional personnel and specialized equipment would be required to prepare the runway because maintenance of the existing skiway would continue to be needed. Operation of a compacted-snow runway would result in similar impacts to those experienced with the existing skiway. Spills and leaks of oil, fuel, lubricants, and other fluids from aircraft, runway construction and maintenance equipment, and fuel storage sites could result in deterioration of the compacted-snow surface and would be cleaned up to the extent possible. To avoid or minimize impacts from contaminated snow materials, NSF would instruct its contractor to collect and process contaminated snow materials to remove contaminants. Contaminated materials would then be transported to McMurdo for appropriate retrograde from Antarctica.

Assuming that the present level of scientific research would be maintained during any construction activities at the South Pole Station, a greater number of flights would occur involving a combination of ski-equipped LC-130 and wheeled C-130 aircraft. As a result of more flights, there would be a higher level of atmospheric emissions from aircraft during this period. Impacts from aircraft emissions have been discussed in the SEIS (NSF 1991), and the increased level of flights that would result from any construction activities at South Pole would not add a sufficient

increment of emissions to cause a significant impact. Development of a compacted-snow runway at the South Pole Station would be a net beneficial impact during any rebuilding project because wheeled aircraft could be used, at least in part, to support science at the South Pole and provide, therefore, more efficient operation, fewer flights to deliver the same amount of cargo, and less fuel used. Long-term development of a runway for wheeled aircraft may not be economically feasible after any rebuilding project has been completed.

Environmental consequences of the no-action alternative

Under the no-action alternative, any reconstruction of the South Pole Station would be dependent on using LC-130s to transport construction materials and equipment or other alternatives such as overland traverse or airdrops. Environmental impacts of using LC-130s would be similar to those from existing operations (NSF 1991). Because of the limited cargo capability of the LC-130s, any construction period would have to be extended. Use of LC-130s to transport construction materials, equipment, and personnel would greatly limit the available support for science and would have a significant adverse impact on the science program. Use of airdrops would increase the cost of transport. Overland traverse of materials from McMurdo is possible, but very expensive, and it would involve an extended risk to the safety and health of personnel involved with the traverse.

Other potential blue-ice runway sites

Affected environment

Very little is known about most of the 84 potential airfield sites identified by Swithinbank (1991). In most cases, no one has ever visited the sites identified from the aerial photographs. One important exception is the Patriot Hills blue-ice site that is located to the north of the isolated Patriot Hills ridge in the Ellsworth Mountains (Fig. B3). The ice field covers a $2\text{-km} \times 8\text{-km}$ area and is low in elevation (750 m) relative to Mount Howe and Mill Glacier. The site has been used for wheel landings of DC-4 aircraft, and temporary camps capable of housing up to 40 people have been maintained during the summer months on the moraine at Patriot Hills (Mellor and Swithinbank 1989). Currently, the site is used for wheel

landings of DC-6 tourism aircraft (Swithinbank 1991).

Environmental consequences of developing other blue-ice runways

Blue-ice runways could be developed at other locations in Antarctica to support scientific activities. If such runways were constructed, impacts resulting from construction would be similar to those discussed for Mount Howe and Mill Glacier and would be less than minor or transitory in nature (that is, of no significant impact). Impacts of using such runways would be similar to those that occur for current LC-130 skiways that are used to support field science parties as discussed in the SEIS (NSF 1991). Should a major field base be developed associated with such a runway, additional environmental documentation would be prepared.

Environmental consequences of the no-action alternative

If no additional blue-ice runways are developed, there should be no new environmental impacts associated with runway development. LC-130s and Twin-Otter type aircraft would continue to be used and landings would be made on snow and ice surfaces and existing skiways.

Cumulative environmental impacts

Cumulative environmental impacts from the USAP developing blue-ice and compacted-snow runways in Antarctica could occur if the numbers of aircraft and flights to and on the continent increased. Increased use of aircraft would result in increased emissions of atmospheric pollutants from aircraft engines and from maintenance equipment and support activities. Additional personnel would be required to maintain and operate aircraft and to handle cargo carried by these planes. More fuel would be required, and the risk of fuel spills and leakage of fuel, oil, and lubricants would increase in proportion to the number of flights added. These cumulative impacts can be minimized with appropriate planning. Use of wheeled aircraft for transporting cargo and passengers is more efficient than use of the ski-equipped LC-130s. C-130s and C-141s use fuel more efficiently, and fewer flights would be required to transport equivalent amounts of cargo and passengers. To meet the USAP goal of reducing the overall environmental impacts of the pro-

gram on Antarctica, it may be necessary to reduce other support activities and possibly science programs during periods of peak construction activity.

FINDINGS

The proposed development of blue-ice and compacted-snow runways to enhance the use of wheeled aircraft by the USAP would cause less than minor or transitory environmental impacts (that is, no significant impacts) and could contribute to the program's goal of reducing human impacts to the Antarctic environment. Adverse environmental impacts that could result from the development and subsequent use of blue-ice and compacted-snow runways include contamination of ice and snow from spills or leaks of fuel, oil, and lubricants, contamination of pristine areas by atmospheric emissions from aircraft and equipment used for construction and maintenance of the runway, disturbance of sensitive wildlife resources by low-flying aircraft, and degradation of the aesthetic environment associated with remote sites where such runways would be located. Use of wheeled aircraft could result in reducing the number of flights required to support USAP activities on the continent that would in turn have the environmental benefits of reduced fuel use and emissions, fewer support personnel needed for operation and maintenance, and greater flexibility for scheduling science activities that could reduce the numbers of support personnel required at peak seasons of the year.

USAP is proposing to develop a compacted-snow or blue-ice runway on an ice shelf at the Pegasus site near McMurdo Station and is evaluating the remote possibility of developing 1) a blue-ice runway at Mount Howe, 2) expanding the use of the runway at Mill Glacier, or 3) developing a compacted-snow runway at the South Pole to transport construction materials and equipment for any rebuilding the South Pole Station. In addition, blue-ice runways may be developed elsewhere in Antarctica to support scientific activities and field camps.

Potential adverse impacts at all of these sites would be less than minor or transitory in nature (that is, they would pose no significant impacts). Fuel spills and leaks would be cleaned up to the extent practicable and all contaminants removed from the snow and ice would be returned to

McMurdo for retrograde from Antarctica. Solid, liquid and sanitary wastes would be placed in containers and returned to McMurdo for disposal.

Atmospheric emissions would be released from aircraft, construction and maintenance equipment, and power generators; the degree to which these emissions would degrade local air quality is anticipated to be both less than minor and transitory (that is, they would pose no significant impacts). The number of flights that would use these runways is not yet determined, but no significant degradation of air quality is anticipated from aircraft operations. The only wildlife populations that could possibly be affected by development of blue-ice or compacted-snow runways are seal and penguin populations in the general vicinity of the Pegasus site. Normal landing and takeoff patterns would avoid the SSSI site on White Island, and no adverse impacts to seals and penguins from low-flying aircraft in the immediate vicinity of McMurdo Station and Scott Base are anticipated because populations in this area are acclimatized to aircraft operations.

Some degradation of the aesthetic environment at blue-ice and compacted-snow runways is unavoidable because of the presence of aircraft, people, construction and maintenance equipment, and structures. At the Pegasus site, this change in aesthetics could be relatively permanent if the runway proves to be successful. A compacted-snow runway at the South Pole Station should have essentially no aesthetic impact as it would require no additional support structures and would be compatible with the existing skiway and station. The aesthetic intrusion of blue-ice runways at other sites in Antarctica is expected to be both less than minor and transitory (that is, of no significant aesthetic impact). In some cases, temporary buildings may be located at such a site for a few years. Because many of these runways require minimal surface preparation, there is little visual intrusion. Aircraft are present at these sites only for short periods of time, and construction and maintenance equipment would be limited and removed when the activity is over.

The findings of this IEE are that development and subsequent use of blue-ice and compacted-snow runways would have less than minor or transitory environmental impacts (that is, no significant environmental impacts are anticipated) and could benefit the program. The benefits of developing such runways could include using

wheeled aircraft to transport personnel to New Zealand at the end of each austral summer research season, thereby making more LC-130s available to support science during this time; possibly extending the austral summer research season or allowing year-round access to McMurdo; being able to transport equipment and supplies to the South Pole more efficiently; providing access to sites that could be used as base camps for major science projects; and, improving safety of Antarctic operations. Greater use of wheeled aircraft would improve the efficiency of support operations because they carry more cargo and use less fuel. Such increases in efficiency could reduce the number of flights needed and could, in turn, reduce the number of support personnel that need to be sent to Antarctica.

LITERATURE CITED

- Abele, G.** (1989) Snow roads and runways. USA Cold Regions Research and Engineering Laboratory, Monograph 90-3.
- Antarctic Treaty Consultative Parties** (1991) Protocol on environmental protection to the Antarctic Treaty. *XI Antarctic Treaty System Consultative Meeting/2/3/2, Madrid, Spain* (3-4 October 1991).
- Blaisdell, G. L., V. Klokov, and D. Diemand** (1992) Development of a wheeled runway for McMurdo on the Ross Ice Shelf. Paper presented at the XXII SCAR Meeting, San Carlos de Bariloche, Argentina, June 1992.
- Draggan, S., and P. Wilkniss** (1993) An operating philosophy for the U.S. Antarctic Program. *Marine Pollution Bulletin*, 25: 9-12.
- Giovinetto, M.B., and C.R. Bentley** (1985) Surface balance in ice drainage systems of Antarctica. *Antarctic Journal of the United States*, 24(4): 6-13.
- Kovacs, A., and G. Abele** (1977) Runway site survey, Pensacola Mountains, Antarctica. USA Cold Regions Research and Engineering Laboratory, Special Report 77-14.
- Mellor, M.** (1988) Hard surface runways in Antarctica. USA Cold Regions Research and Engineering Laboratory, Special Report 88-13.
- Mellor, M., and C. Swithinbank** (1989) Airfields on Antarctic glacier ice. USA Cold Regions Research and Engineering Laboratory, CRREL Report 89-21.
- National Science Foundation** (1990) Environmental Action Memorandum on the Installation of an Experimental Runway at the Pegasus

Site. Division of Polar Programs, Washington, D.C. (October 3).

National Science Foundation (1991) Final Supplemental Environmental Impact Statement on the U.S. Antarctic Program. Division of Polar Programs, Washington, D.C. (October).

Schwerdtfeger, W. (1984) *Weather and Climate of Antarctica*. New York: Elsevier Science Publishing Co.

Swithinbank, C. (1989) Ice runways near the South Pole. USA Cold Regions Research and Engineering Laboratory, Special Report 89-19.

Swithinbank, C. (1991) Potential airfields sites in Antarctica for wheeled aircraft. USA Cold Regions Research and Engineering Laboratory, CRREL Report 91-24.

USAP Safety Review Panel (1988) Safety in Antarctica. National Science Foundation, Washington, D.C.

APPENDIX C: CROSS-SECTIONAL PROFILES OVER TIME OF THE PEGASUS RUNWAY INCLUDING FLANKING BERMS

Because of concerns about the long-term effect of the concentration of construction spoil along the flanks of the runway, we have performed periodic surveys perpendicular to the long dimension of the runway. The primary concern is that the berms along the east and west sides of the runway will act to trap snow and increase the local accumulation rate enough to make snow management on the runway too labor intensive. In addition, we are concerned how the shape of the berms change (particularly the height-to-width ratio) as a result of removing the summer's protective snow cover from the runway. This snow is

difficult to remove beyond the existing berms and there is concern that the height of the berms will increase each season of operation.

Our goal in generating the survey data was to document over time changes in the shape and volume of the berms. From these data, the approximate rate of snow accumulation on the runway and in the immediate vicinity can be calculated. Construction activities to shape the berms occurred during the interval over which we collected some of this survey data, particularly on the west flank.

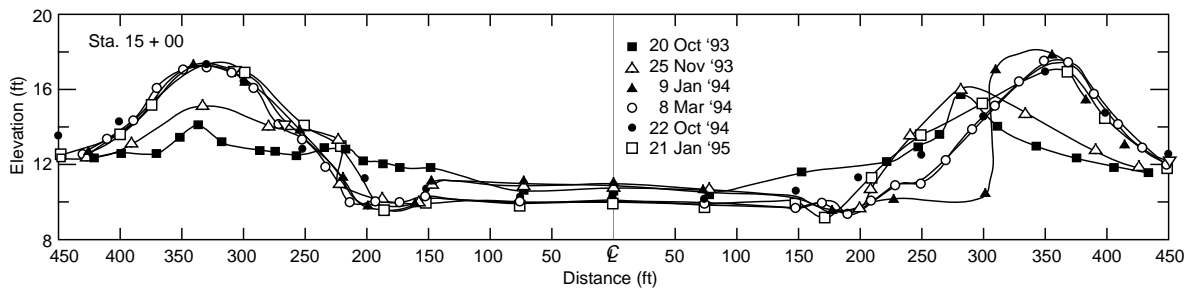

Figure C1. Survey profile of the snow surface over time (looking south down the runway centerline) at the 1500-ft station on the runway.

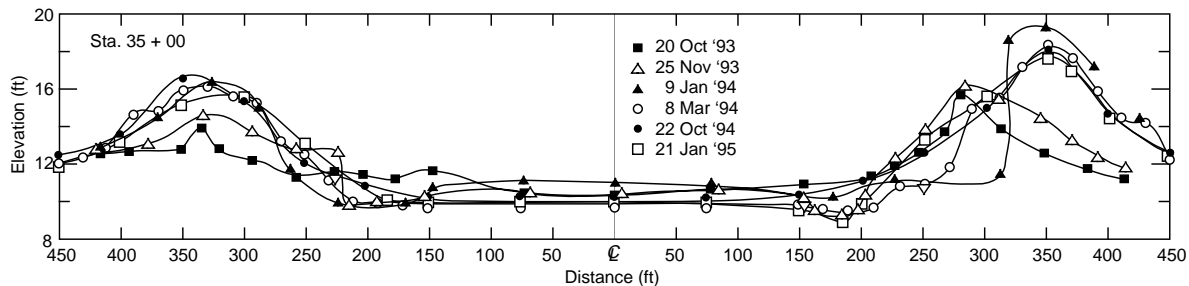

Figure C2. Survey profile of the snow surface over time (looking south down the runway centerline) at the 3500-ft station on the runway.

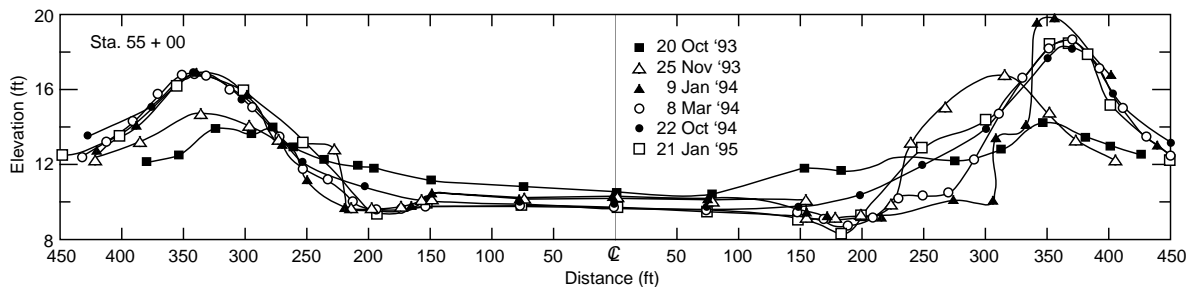

Figure C3. Survey profile of the snow surface over time (looking south down the runway centerline) at the 5500-ft station on the runway.

Figures C1–C5 depict the snow surface profile extending out 140 m (450 ft) to the east and west from the centerline of the runway. Profiles were taken between 20 October 1993 and 21 January 1995 at the 1500-ft, 3500-ft, 5500-ft, 7500-ft, and 9500-ft stations along the runway (distance is measured from the north end of the runway). The cross sections are shown looking south (east is to the left in Fig. C1–C5).

It is clear from the profiles that the east side of the runway is fairly stable, from 1994 on, along the entire length of the runway. Since the prevailing wind is from the east and it often carries snow from the accumulation zone, it is fortunate that the east berm's shape and height appear to have

stabilized. Use of heavy equipment to reshape and spread out the west berm has caused its shape to change significantly over the span of time covered by these profiles. Without calculating volumes, it is difficult to tell whether there has been any change in the quantity of snow present along this side of the runway. However, clearly the west berm is higher than that on the east and that the west berm has a shallower slope on the runway side than on the outside slope. Since the zone of ablation is not far distant from the west berm, and prevailing winds are from the east, this west berm may not be as threatening as it first appears. Efforts to reduce and reshape the west berm to look more like the east berm are advisable.

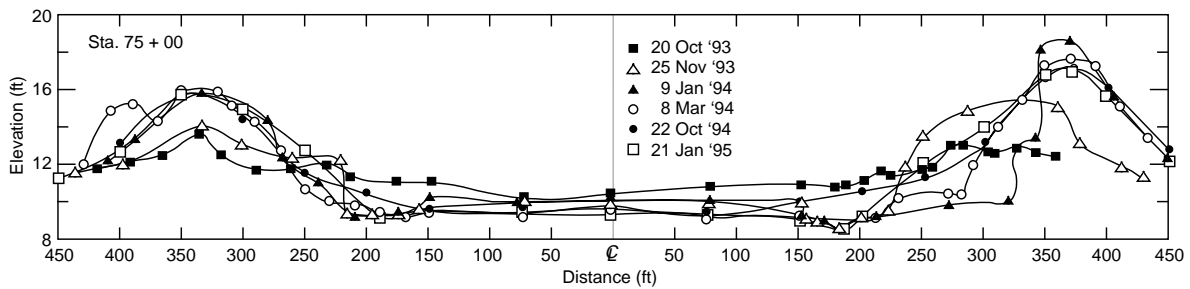

Figure C4. Survey profile of the snow surface over time (looking south down the runway centerline) at the 7500-ft station on the runway.

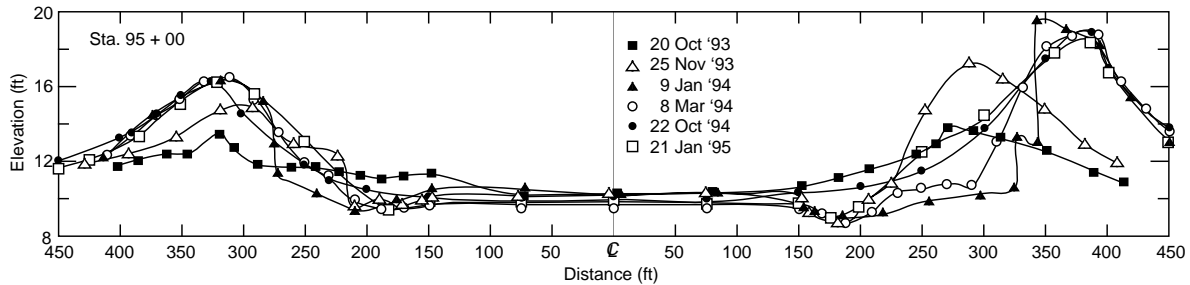

Figure C5. Survey profile of the snow surface over time (looking south down the runway centerline) at the 9500-ft station on the runway.

APPENDIX D: TEMPERATURE PROFILES FROM THE PEGASUS RUNWAY ICE

Temperature profiles within the ice along the east edge of the runway were automatically recorded during the 1992–93 and 1993–94 austral summer seasons. Type T thermocouple strings were installed in the ice extending down to a depth of about 1.5 m (5 ft). Thermocouple leads were brought into a snow-covered weather-proof box and connected to a Campbell Scientific data logger.

Figures D1–D4 show the daily peak ice temperature measured at various depths in the ice during the 1992–93 operational season. Figures D5–D7 present the peak temperatures during the

following season (1993–94). Decisions about placement and removal of snow cover for the runway, proof rolling, and when to allow aircraft access were based on these data.

Figures D8–D14 portray the average daily ice temperature corresponding with Figures D1–D7. In part, the effectiveness of the runway snow cover in protecting the ice from solar radiation can be judged by the difference between maximum and average daily temperatures. Processing of the protective snow cover is required when the peak and average temperatures differ by more than a few degrees.

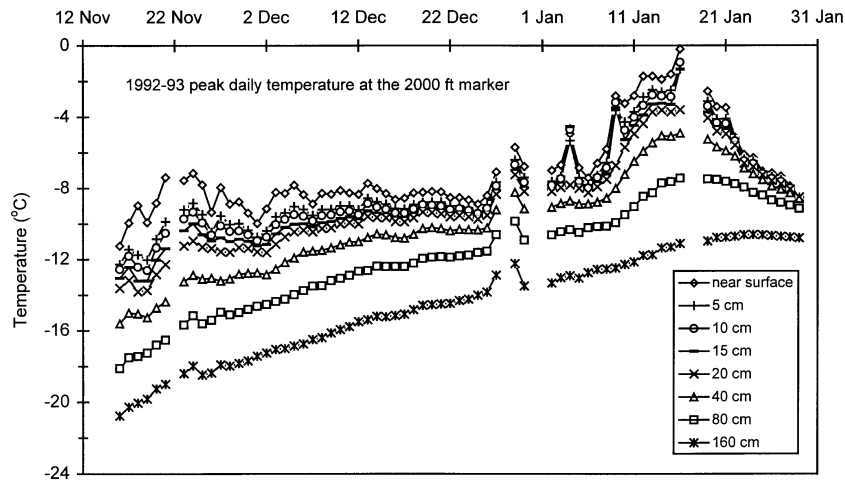

Figure D1. Peak daily temperature in the runway ice at the 2000-ft station during the 1992–93 austral summer.

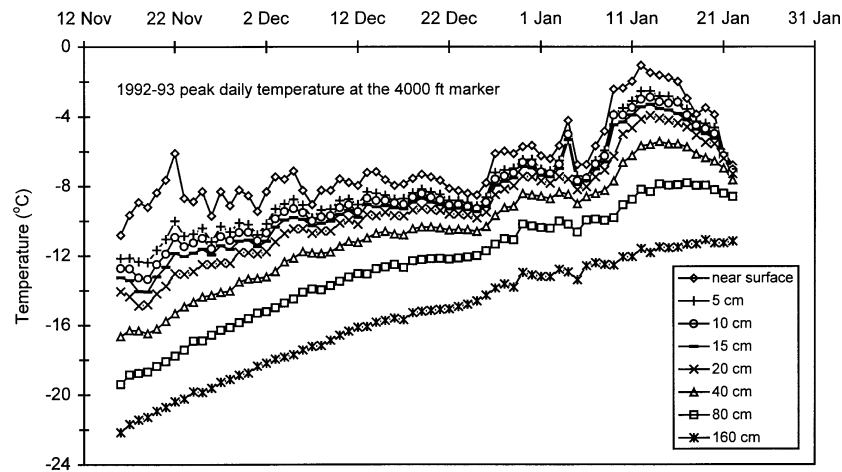

Figure D2. Peak daily temperature in the runway ice at the 4000-ft station during the 1992–93 austral summer.

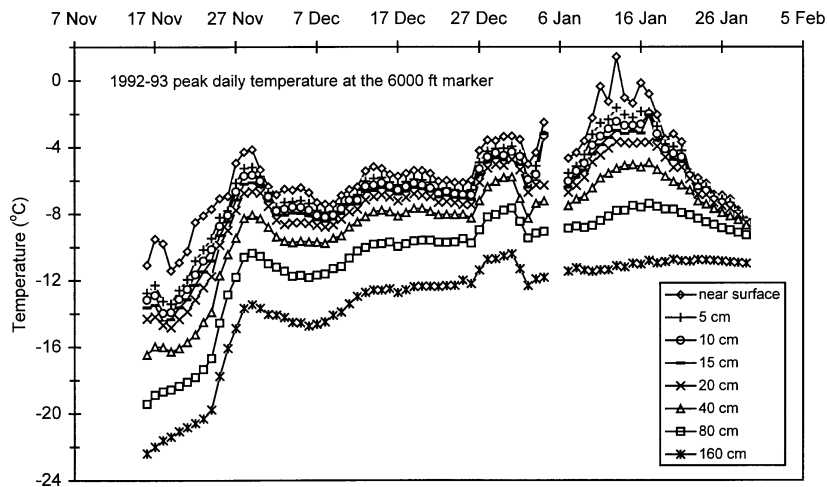

Figure D3. Peak daily temperature in the runway ice at the 6000-ft station during the 1992-93 austral summer.

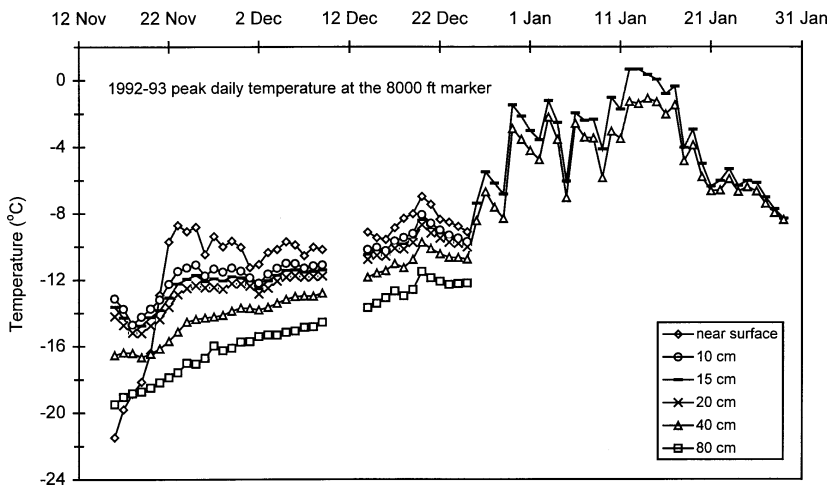

Figure D4. Peak daily temperature in the runway ice at the 8000-ft station during the 1992-93 austral summer.

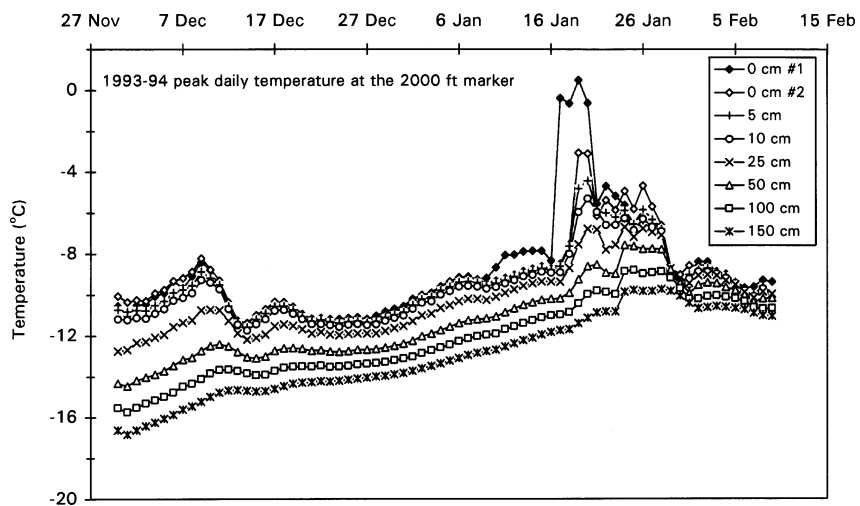

Figure D5. Peak daily temperature in the runway ice at the 2000-ft station during the 1993-94 austral summer.

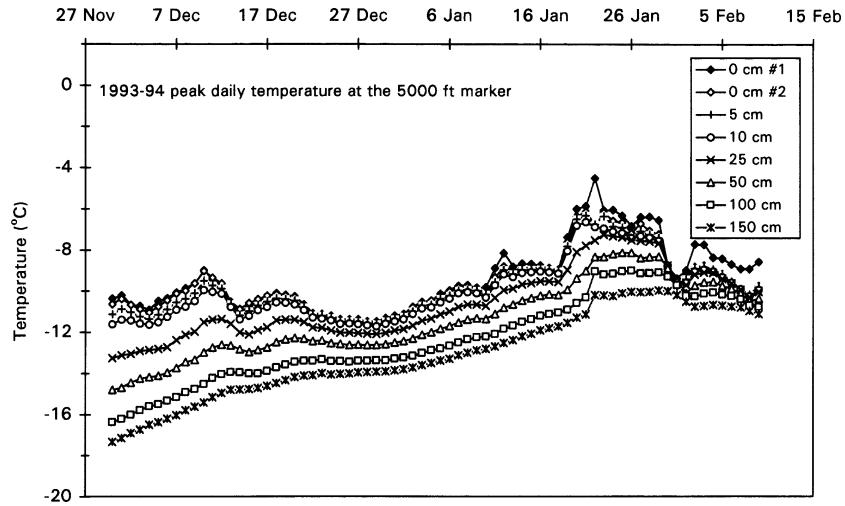

Figure D6. Peak daily temperature in the runway ice at the 5000-ft station during the 1993-94 austral summer.

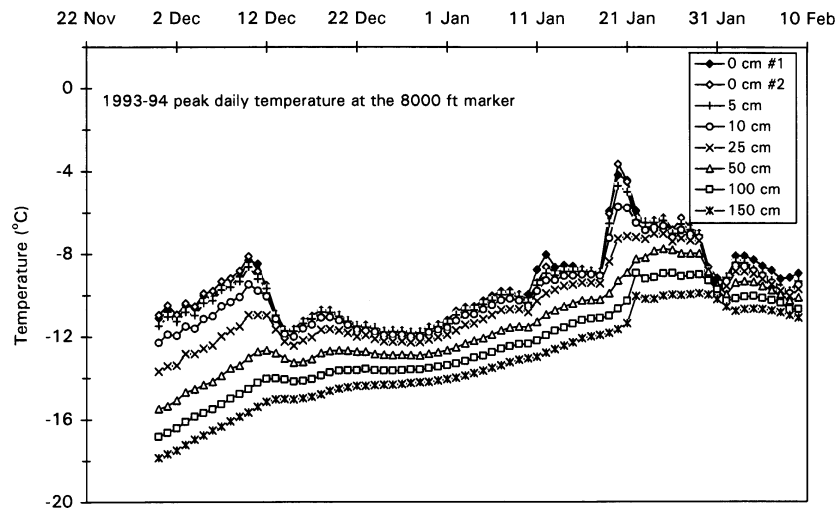

Figure D7. Peak daily temperature in the runway ice at the 8000-ft station during the 1993-94 austral summer.

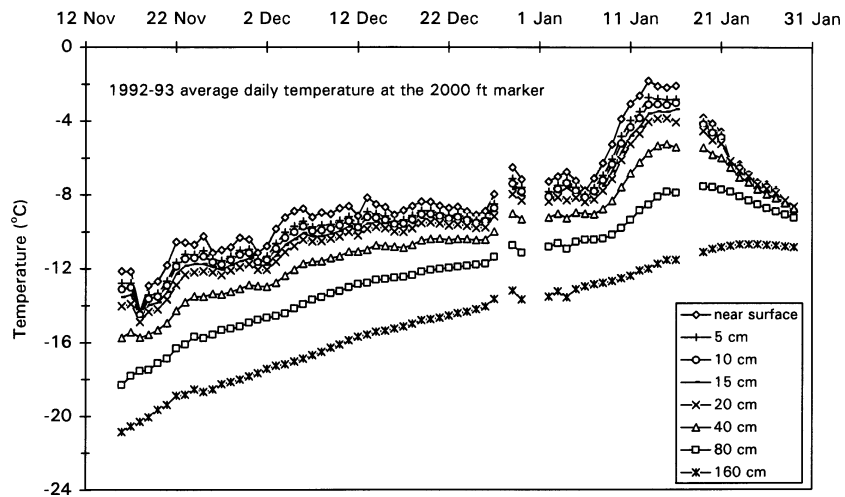

Figure D8. Average daily temperature in the runway ice at the 2000-ft station during the 1992-93 austral summer.

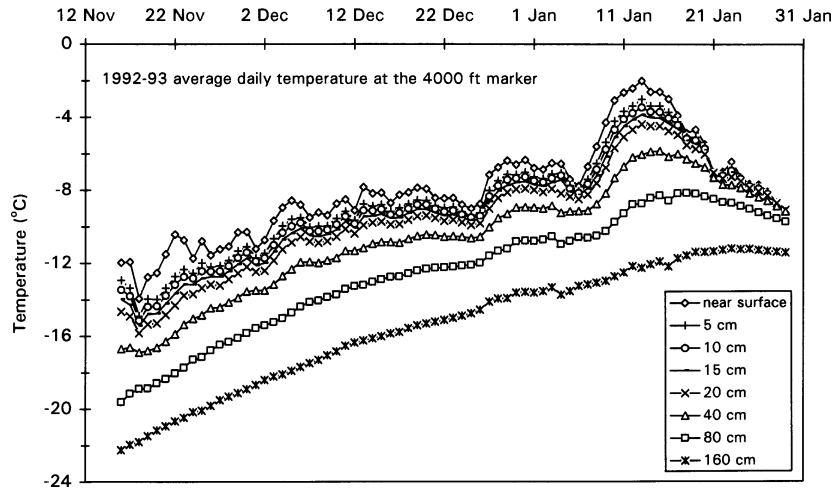

Figure D9. Average daily temperature in the runway ice at the 4000-ft station during the 1992-93 austral summer.

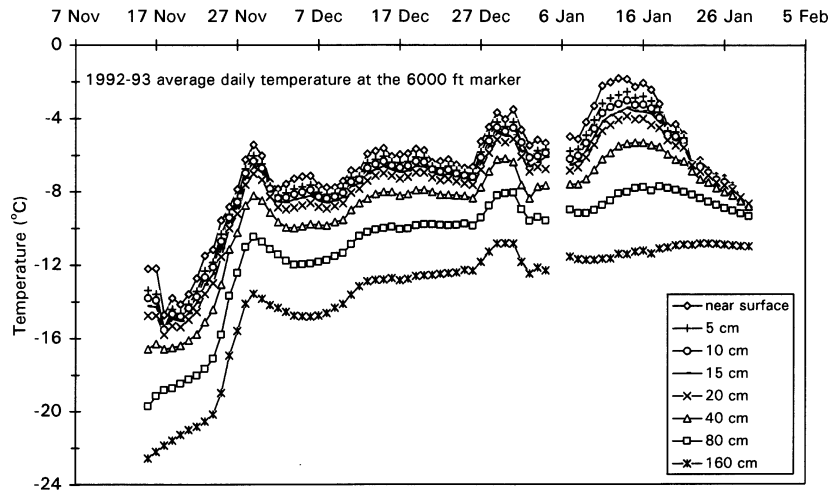

Figure D10. Average daily temperature in the runway ice at the 6000-ft station during the 1992-93 austral summer.

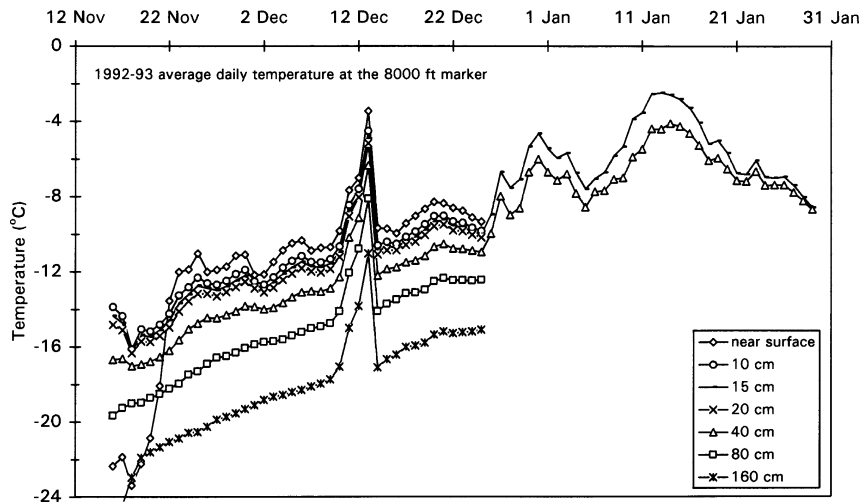

Figure D11. Average daily temperature in the runway ice at the 8000-ft station during the 1992-93 austral summer.

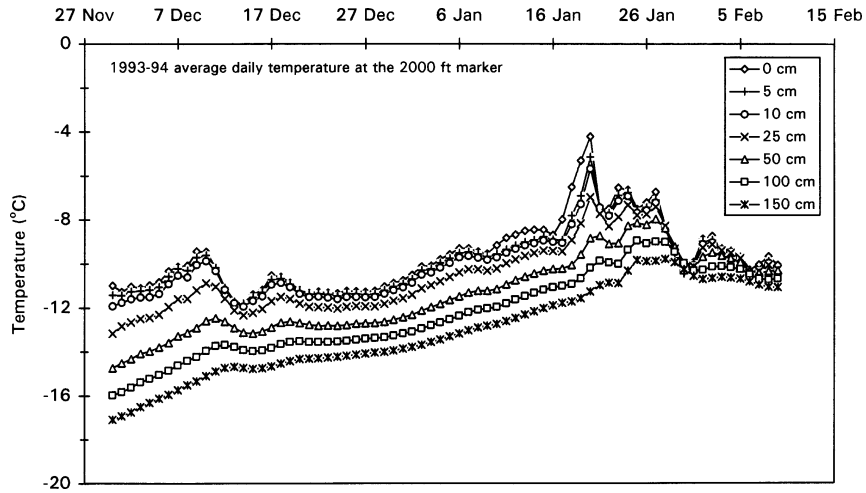

Figure D12. Average daily temperature in the runway ice at the 2000-ft station during the 1993–94 austral summer.

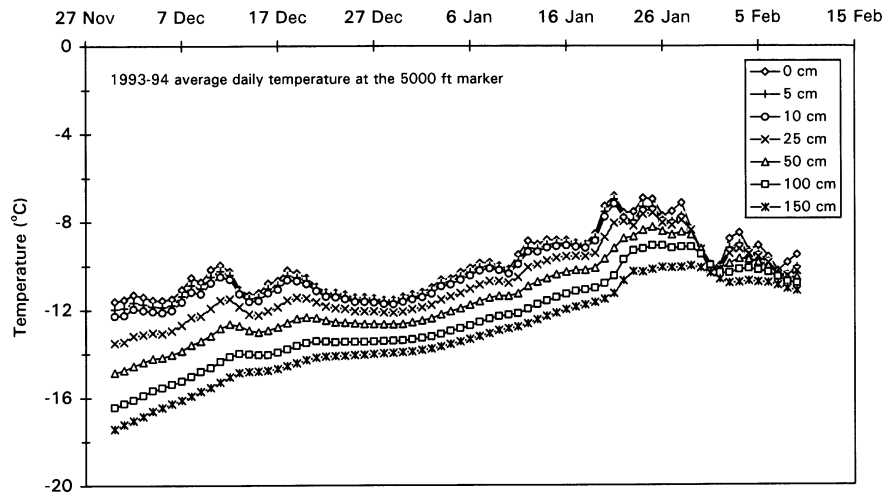

Figure D13. Average daily temperature in the runway ice at the 5000-ft station during the 1993–94 austral summer.

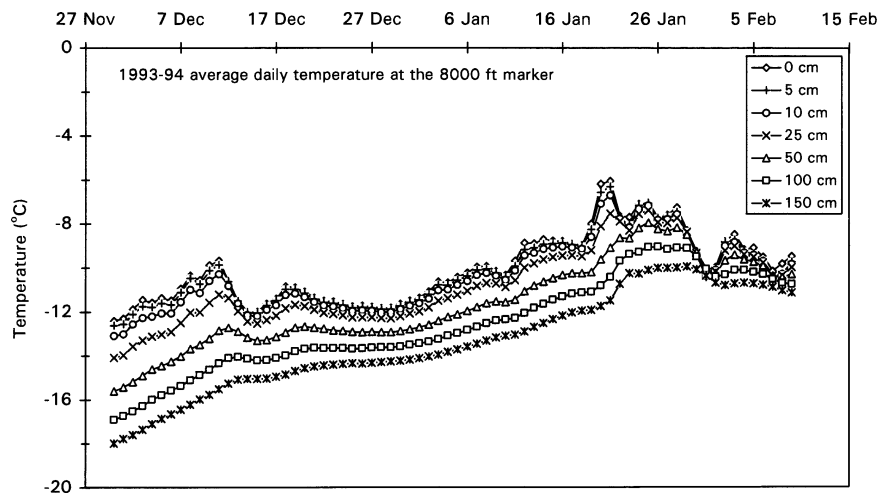

Figure D14. Average daily temperature in the runway ice at the 8000-ft station during the 1993–94 austral summer.

APPENDIX E: AS-BUILT LAYOUT OF THE PEGASUS RUNWAY AND RUNWAY MARKERS

The Pegasus runway layout is shown in Figure E1. Included are the positions of the lead-in markers, the ground plane approach markers, and the distance remaining boards. The approximate

positions of the access roads and supporting infrastructure are also shown. Figure E2 gives details of marker sizes, shapes, and arrangements.

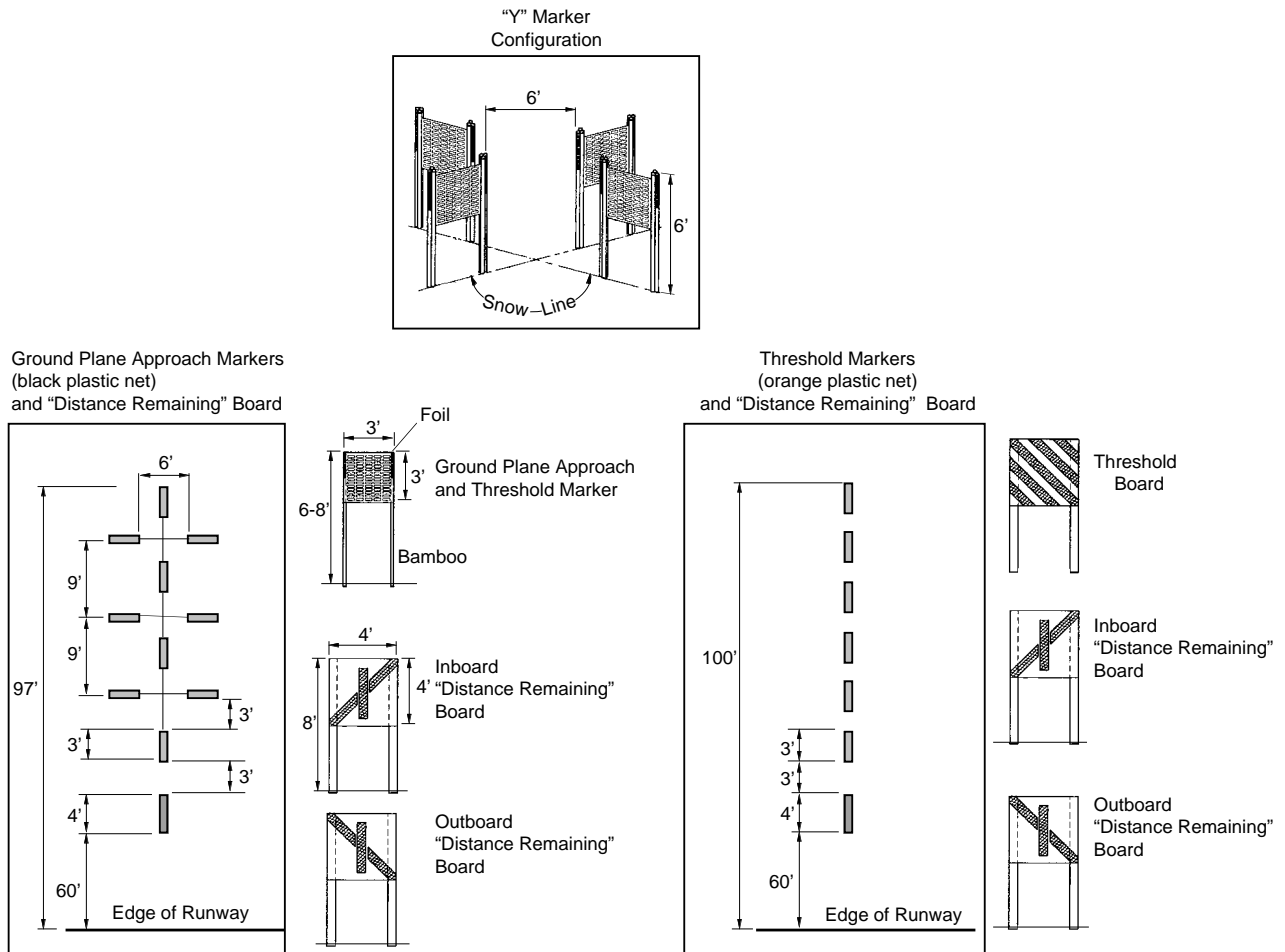

Figure E1. Layout of Pegasus runway and lead-in markers.

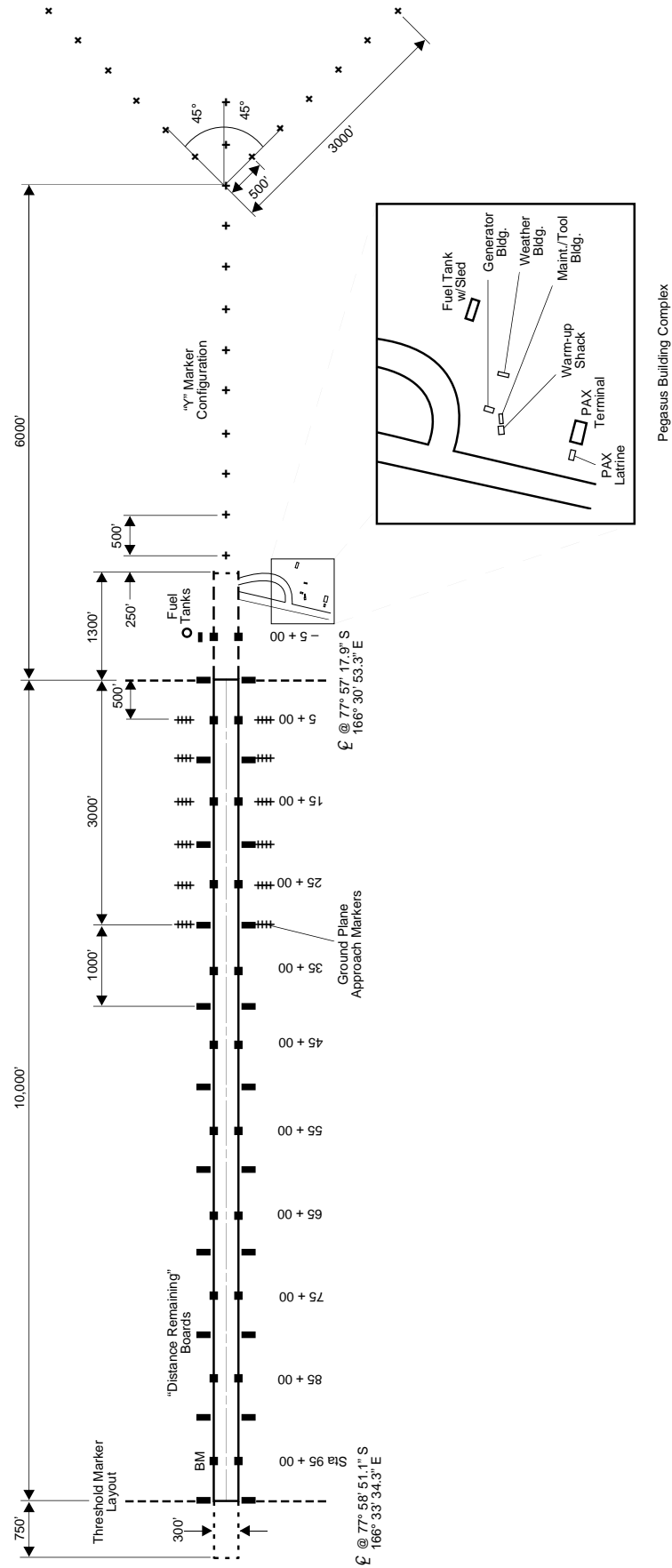

Figure E2. Details of markers for distance remaining, lead in, and ground plane definition.

REPORT DOCUMENTATION PAGE

Form Approved
OMB No. 0704-0188

Public reporting burden for this collection of information is estimated to average 1 hour per response, including the time for reviewing instructions, searching existing data sources, gathering and maintaining the data needed, and completing and reviewing the collection of information. Send comments regarding this burden estimate or any other aspect of this collection of information, including suggestion for reducing this burden, to Washington Headquarters Services, Directorate for Information Operations and Reports, 1215 Jefferson Davis Highway, Suite 1204, Arlington, VA 22202-4302, and to the Office of Management and Budget, Paperwork Reduction Project (0704-0188), Washington, DC 20503.

1. AGENCY USE ONLY (Leave blank)		2. REPORT DATE March 1998		3. REPORT TYPE AND DATES COVERED	
4. TITLE AND SUBTITLE Construction, Maintenance, and Operation of a Glacial Ice Runway, McMurdo Station, Antarctica				5. FUNDING NUMBERS	
6. AUTHORS George L. Blaisdell, Renee M. Lang, Gerald Crist, Keith Kurtti, R. Jeffrey Harbin, and Daniel Flora					
7. PERFORMING ORGANIZATION NAME(S) AND ADDRESS(ES) U.S. Army Cold Regions Research and Engineering Laboratory 72 Lyme Road Hanover, New Hampshire 03755-1290				8. PERFORMING ORGANIZATION REPORT NUMBER Monograph 98-1	
9. SPONSORING/MONITORING AGENCY NAME(S) AND ADDRESS(ES) Office of Polar Programs National Science Foundation Washington, D.C.				10. SPONSORING/MONITORING AGENCY REPORT NUMBER	
11. SUPPLEMENTARY NOTES					
12a. DISTRIBUTION/AVAILABILITY STATEMENT Approved for public release; distribution is unlimited. Available from NTIS, Springfield, Virginia 22161				12b. DISTRIBUTION CODE	
13. ABSTRACT (<i>Maximum 200 words</i>) On 7 February 1994, a C-141 departed Christchurch, New Zealand, and landed on the 3050-m (10,000-ft) Pegasus glacial ice runway, located on the Ross Ice Shelf 13 km (8 miles) south of McMurdo, Antarctica. This event marked the final test for a five-year development program to demonstrate the feasibility of a semipermanent glacial ice runway capable of supporting heavy wheeled aircraft at a site easily accessible to McMurdo. In the later phases of developing the glacial ice runway, numerous working flights of LC-130s operating on wheels (rather than skis) moved cargo more efficiently to the South Pole, and the LC-130 and a C-130 carried larger passenger loads to Christchurch. The primary benefit of the Pegasus runway to the U.S. Antarctic Program is its ability to support heavy wheeled aircraft for most of the period of mid-January through November. In the past, only ski-equipped aircraft could land in the McMurdo area during this time period. The Pegasus runway allows increased payloads for the LC-130 (an additional 3600-kg or 8000-lb takeoff weight when using wheels) and provides access for virtually any conventional aircraft. The technology for siting, constructing, maintaining, and operating such a runway is now well understood and is described in detail in this comprehensive report.					
14. SUBJECT TERMS Construction Glacial ice Maintenance McMurdo, Antarctica Operations Runways				15. NUMBER OF PAGES 139	
				16. PRICE CODE	
17. SECURITY CLASSIFICATION OF REPORT UNCLASSIFIED		18. SECURITY CLASSIFICATION OF THIS PAGE UNCLASSIFIED		19. SECURITY CLASSIFICATION OF ABSTRACT UNCLASSIFIED	
				20. LIMITATION OF ABSTRACT UL	